



iPad not included

LINK™

User Guide

©2022 ADJ PRODUCTS LLC all rights reserved. Information, specifications, diagrams, images, and instructions herein are subject to change without notice. ADJ logo and identifying product names and numbers herein are trademarks of ADJ PRODUCTS LLC. Copyright protection claimed includes all forms and matters of copyrightable materials and information now allowed by statutory or judicial law or hereinafter granted. Product names used in this document may be trademarks or registered trademarks of their respective companies and are hereby acknowledged. All non-ADJ brands and product names are trademarks or registered trademarks of their respective companies.

ADJ PRODUCTS LLC and all affiliated companies hereby disclaim any and all liabilities for property, equipment, building, and electrical damages, injuries to any persons, and direct or indirect economic loss associated with the use or reliance of any information contained within this document, and/or as a result of the improper, unsafe, insufficient and negligent assembly, installation, rigging, and operation of this product.

ADJ PRODUCTS LLC USA

6122 S. Eastern Ave. Los Angeles, CA 90040
323-582-2650 | Fax 323-532-2941 | www.adj.com | info@adj.com

ADJ SUPPLY Europe B.V

Junostraat 2 6468 EW Kerkrade, The Netherlands
+31 (0)45 546 85 00 | Fax +31 45 546 85 99 | www.adj.eu | info@americandj.eu

ADJ PRODUCTS GROUP Mexico

AV Santa Ana 30 Parque Industrial Lerma, Lerma, Mexico 52000
+52 (728) 282-7070 | ventas@adj.com

FCC STATEMENT

This device complies with Part 15 of the FCC Rules. Operation is subject to the following two conditions: (1) this device may not cause harmful interference, and (2) this device must accept any interference received, including interference that may cause undesired operation.

D O C U M E N T V E R S I O N



Due to additional product features and/or enhancements, an updated version of this document may be available online, along with an App Manual, and or other supplementary documents.

Please check www.adj.com for the latest revision/update of this user guide, or to download the App Manual before beginning installation, and/or programming.

Date	Document Version	Notes
12/02/20	1	Initial Release
02/25/21	1.5	Updated Specifications
11/28/22	2.0	Removed firmware update

CONTENTS

General Information	4
Limited Warranty	5
Safety Guidelines	6
Overview	7
Faders	8
Matrix Page	9
Matrix Buttons	9
App Shortcut Buttons	10
Jog Wheels	10
Master Fader and Blackout Button	11
USB LED Light	12
Rear Panel	13
Connecting to the Link Controller	14
Rack Mounting Hardware	15
Technical Specifications	16
Dimensional Drawings	17
FCC Compliance	18

GENERAL INFORMATION

INTRODUCTION

Please read and understand the instructions in this manual carefully and thoroughly before attempting to operate this device. These instructions contain important safety and use information.

UNPACKING

Every device has been thoroughly tested and has been shipped in perfect operating condition. Carefully check the shipping carton for damage that may have occurred during shipping. If the carton is damaged, carefully inspect the device for damage, and be sure all accessories necessary to install and operate the device have arrived intact. In the event damage has been found or parts are missing, please contact our customer support team for further instructions. Please do not return this device to your dealer without first contacting customer support. Please do not discard the shipping carton in the trash. Please recycle whenever possible.

BOX CONTENTS

- USB Cable
- USB Light
- DC9V Power Supply
- Rack Mount Kit

CUSTOMER SUPPORT

Contact ADJ Service for any product related service and support needs.

Also visit forums.adj.com with questions, comments or suggestions.

ADJ SERVICE USA - Monday - Friday 8:00am to 4:30pm PST

323-582-2650 | Fax: 323-832-2941 | support@adj.com

ADJ SERVICE EUROPE - Monday - Friday 08:30 to 17:00 CET

+31 45 546 85 60 | Fax: +31 45 546 85 96 | support@adj.eu

LIMITED WARRANTY

- A. ADJ Products, LLC hereby warrants, to the original purchaser, ADJ Products, LLC products to be free of manufacturing defects in material and workmanship for a prescribed period from the date of purchase (see specific warranty period on reverse). This warranty shall be valid only if the product is purchased within the United States of America, including possessions and territories. It is the owner's responsibility to establish the date and place of purchase by acceptable evidence, at the time service is sought.
- B. For warranty service, you must obtain a Return Authorization number (RA#) before sending the product back— please contact ADJ Products, LLC Service Department at 800-322-6337. Send the product only to the ADJ Products, LLC factory. All shipping charges must be prepaid. If the requested repairs or service (including parts replacement) are within the terms of this warranty, ADJ Products, LLC will pay return shipping charges only to a designated point within the United States. If the entire instrument is sent, it must be shipped in its original package and packaging material. No accessories should be shipped with the product. If any accessories are shipped with the product, ADJ Products, LLC shall incur no liability whatsoever for loss of or damage to any such accessories, nor for the safe return thereof.
- C. This warranty is void if the product serial number and/or labels are altered or removed; if the product is modified in any manner which ADJ Products, LLC concludes, after inspection, affects the reliability of the product; if the product has been repaired or serviced by anyone other than the ADJ Products, LLC factory unless prior written authorization was issued to purchaser by ADJ Products, LLC; if the product is damaged because it was not properly maintained as set forth in the product instructions, guidelines and/or user manual.
- D. This is not a service contract, and this warranty does not include maintenance, cleaning, or periodic checkup. During the period specified above, ADJ Products, LLC will replace defective parts at its expense with new or refurbished parts, and will absorb all expenses for warranty service and repair labor by reason of defects in material or workmanship. The sole responsibility of ADJ Products, LLC under this warranty shall be limited to the repair of the product, or replacement thereof, including parts, at the sole discretion of ADJ Products, LLC. All products covered by this warranty were manufactured after August 15, 2012, and bear identifying marks to that effect.
- E. ADJ Products, LLC reserves the right to make changes in design and/or improvements upon its products without any obligation to include these changes in any products theretofore manufactured.
- F. No warranty, whether expressed or implied, is given or made with respect to any accessory supplied with products described above. Except to the extent prohibited by applicable law, all implied warranties made by ADJ Products, LLC in connection with this product, including warranties of merchantability or fitness, are limited in duration to the warranty period set forth above. And all warranties, whether expressed or implied, including warranties of merchantability or fitness, are limited in duration to the warranty period set forth above. The consumer's and/or dealer's sole remedy shall be such repair or replacement as is expressly provided above; and under no circumstances shall ADJ Product, LLC be liable for any loss and/or damage, direct and/or consequential arising out of the use of, and/or inability to use this product.
- G. This warranty is the only written warranty applicable to ADJ Products, LLC products, and supersedes all prior warranties and written descriptions of warranty terms and conditions heretofore published.

MANUFACTURER'S LIMITED WARRANTY PERIODS:

Non-LED Lighting Products = 1-Year (365 Days) (Including Special Effect Lighting, Intelligent Lighting, UV lighting, Strobes, Fog Machines, Bubble Machines, Mirror Balls, Par Cans, Trussing, Lighting Stands, Power/Data Distribution, etc. excluding LED and lamps)

Laser Products = 1-Year (365 Days) (excluding laser diodes which have a 6-Month Limited Warranty)

LED Products = 2-Year (730 Days) (excluding batteries which have a 180 Day Limited Warranty)

NOTE: 2-Year (730 Days) Limited Warranty ONLY applies to product purchased within the United States.

StarTec Series = 1-Year (365 Days) (excluding batteries which have a 180 Day Limited Warranty)

ADJ DMX Controllers = 2 Year (730 Days)

American Audio Products = 1 Year (365 Days)

CUSTOMER SUPPORT INFORMATION

Contact ADJ Service for any product related service and support needs.

Also visit forums.adj.com with questions, comments or suggestions.

ADJ SERVICE USA - Monday - Friday 8:00am to 4:30pm PST

323-582-2650 | Fax: 323-832-2941 | support@adj.com

ADJ SERVICE EUROPE - Monday - Friday 08:30 to 17:00 CET

+31 45 546 85 60 | Fax: +31 45 546 85 96 | support@adj.eu

SAFETY GUIDELINES

This device is an extremely sophisticated piece of electronic equipment. To guarantee a smooth operation, it is important to follow the guidelines in this manual. The manufacturer of this device will not accept responsibility for damages resulting from the misuse of this fixture due to the disregard of the information printed in this manual.

THERE ARE NO USER SERVICEABLE PARTS INSIDE THIS DEVICE.



DO NOT ATTEMPT ANY REPAIRS YOURSELF; DOING SO WILL VOID YOUR MANUFACTURES WARRANTY. DAMAGES RESULTING FROM MODIFICATIONS TO THIS PANEL AND/OR THE DISREGARD OF SAFETY INSTRUCTIONS AND GUIDELINES IN THIS MANUAL VOID THE MANUFACTURES WARRANTY AND ARE NOT SUBJECT TO ANY WARRANTY CLAIMS AND/OR REPAIRS.



INDOOR / DRY LOCATIONS USE ONLY!

DO NOT EXPOSE DEVICE TO RAIN AND/OR MOISTURE!

DO NOT SPILL WATER AND/OR LIQUIDS ON OR INTO THE DEVICE!

DO NOT operate this device if any cover is open and/or removed.

DO NOT shake device, avoid brute force when installing and/or operating device.

DO NOT expose any part of the device to open flame or smoke. Keep it away from heat sources such as radiators, heat registers, stoves, or other appliances (including amplifiers) that produce heat.

DO NOT use device in extreme hot/humid environments, or handle without ESD precautions.

DO NOT operate device if power cord is frayed, crimped, damaged and/or if any of the power cord connectors are damaged and do not insert into the panel securely with ease. **NEVER** force a power cord connector into the device. If the power cord or any of its connectors are damaged, replace it immediately with a new one of similar power rating.

ALWAYS disconnect device from main power source before performing any type of service and/or cleaning procedure. Only handle the power cord by the plug end, never pull out the plug by tugging the wire portion of the cord.

OVERVIEW

LINK is a 4-DMX 512 universe lighting controller for controlling compatible DMX devices using the dedicated **LINK App** for iPad available on the Apple store (free app).

LINK creates a private standalone 2.4 or 5 GHz Wi-Fi network, which coexists in busy RF environments alongside other wireless technologies. No existing network infrastructure is required.

LINK is ideal for small production events, nightclubs, bars or any event or venue which requires the flexibility of wireless iPad control, and who are looking for a robust, 4 DMX universe APP based lighting control solution.

LINK App compatibility:

Compatible with iPad only. Requires iOS 12 or later. *iPad NOT included.

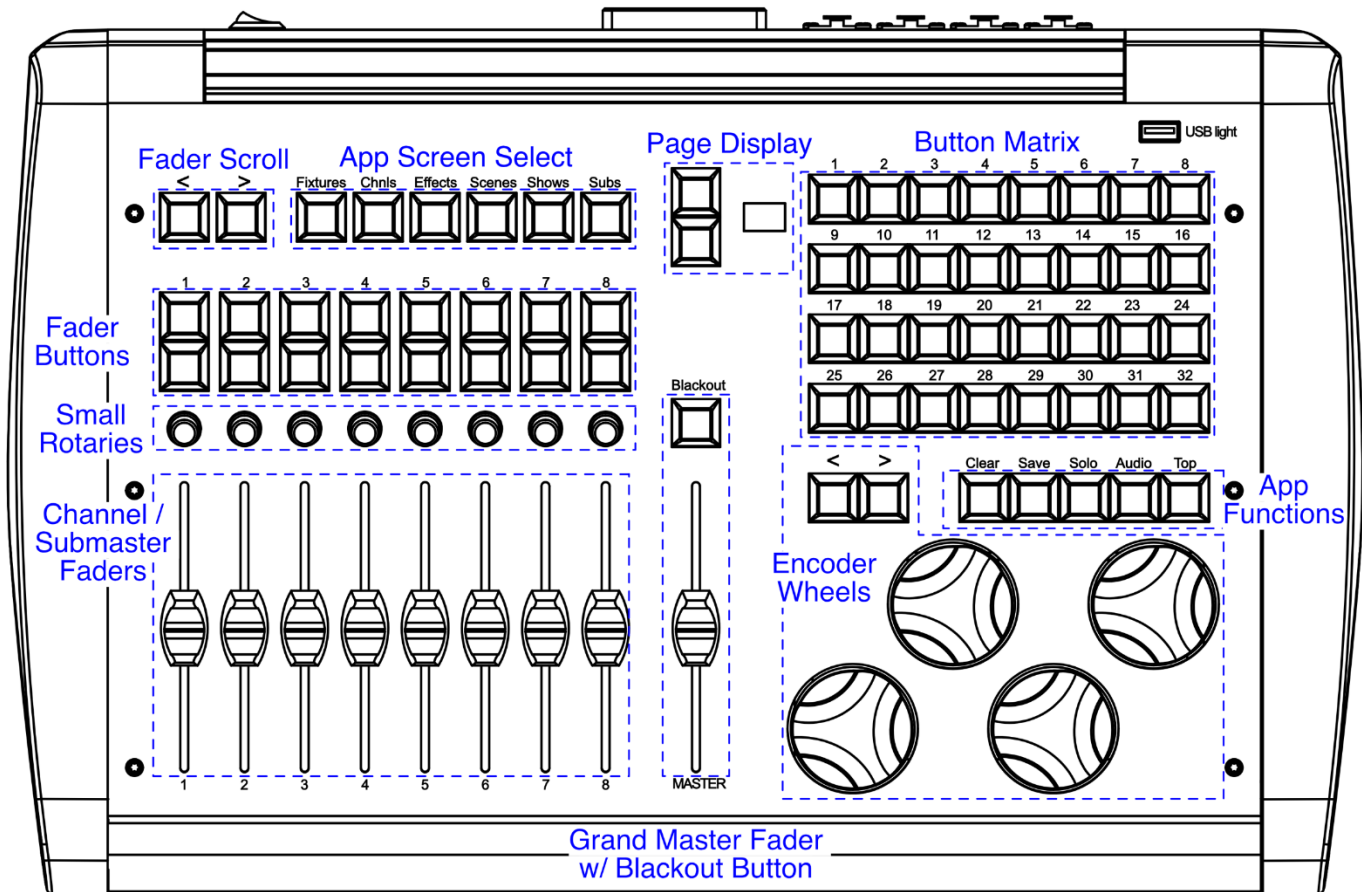

FADERS: 8 faders each with 1 rotary push-in style knob, 2 buttons and fader scroll left/right buttons.

MASTER FADER and BLACKOUT BUTTON: Located in the center of the controller.

SHORTCUTS: 6 shortcut buttons located above the playback buttons for selecting app views on the iPad, and 5 general purpose shortcut buttons located above the 4 jog wheels.

MATRIX BUTTONS: 32 matrix buttons and matrix page select buttons and a display.

JOG WHEELS: There are 4 large wheels for control of lighting parameters. The wheels are also push buttons that allow you to press in on the wheel for additional functions.

FADERS

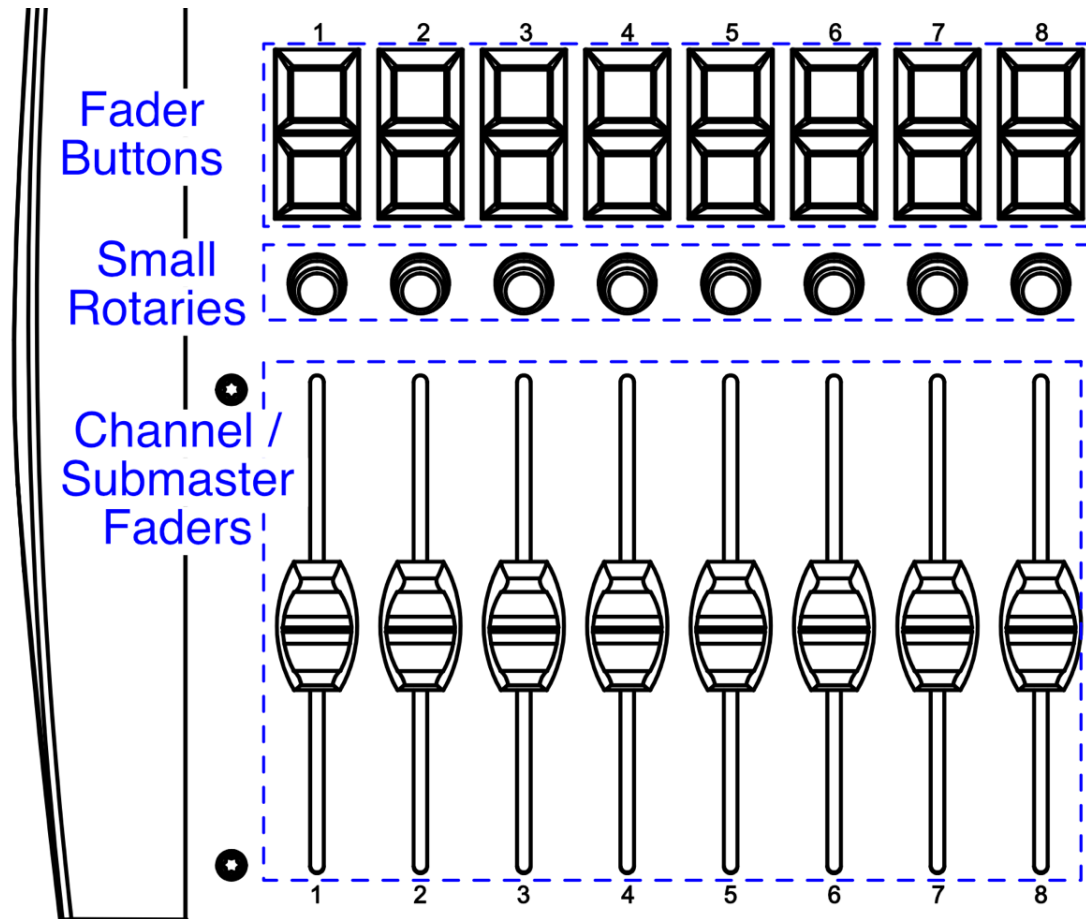

The fader section is used for fixture channel control or for scene sub-masters.

The rotary knobs above each fader are used for fine control when controlling channel levels and as effect speed controls when used as sub-masters.

The fader buttons are used to add or subtract channels when in channel mode or as scene buttons when in sub-master mode. There is an LED in the top button to show active channels or sub-masters.

MATRIX PAGE

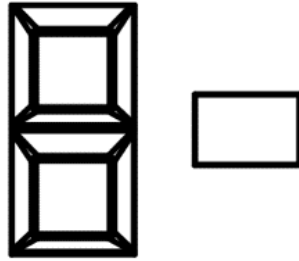

The 32 matrix buttons correspond to the views on the iPad app that use buttons, for example fixture selection or scene selection. The page control allows you to change button pages.

MATRIX BUTTONS

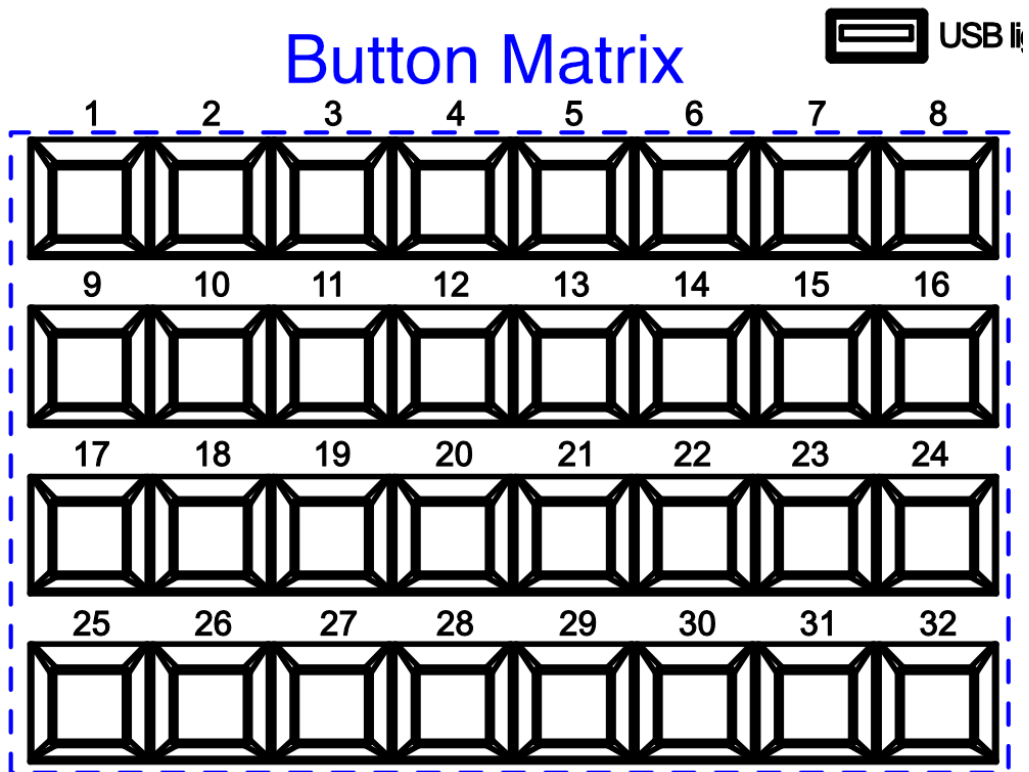

These 32 buttons can be used to call lighting effects, scenes, colors, etc. and correspond to the views in the Link app that use buttons.

The 32 matrix buttons can be paged using the page controls to their upper left.

APP SHORTCUT BUTTONS

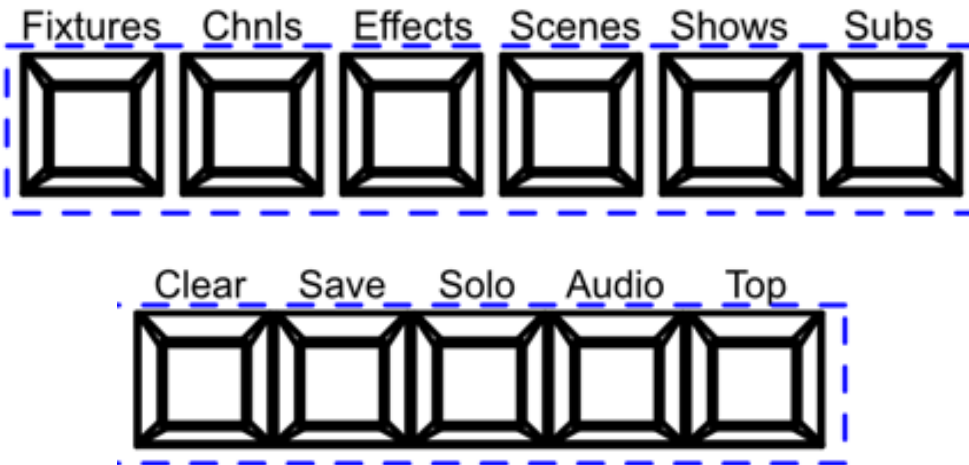

These 11 buttons are intended for frequently used functions in the Link app.

JOG WHEELS

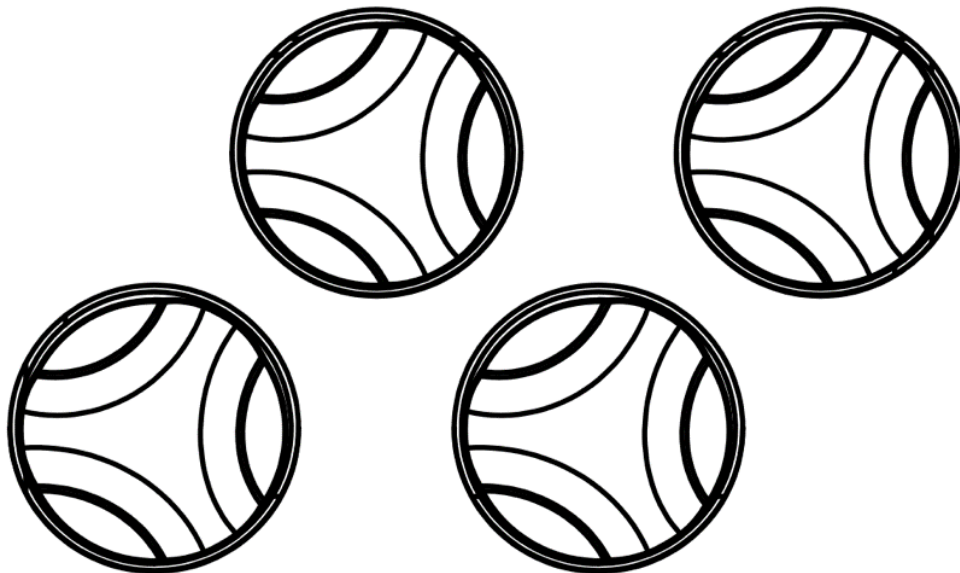

The jog wheels are used throughout the app for controlling various functions and features.

MASTER FADER AND BLACKOUT BUTTON

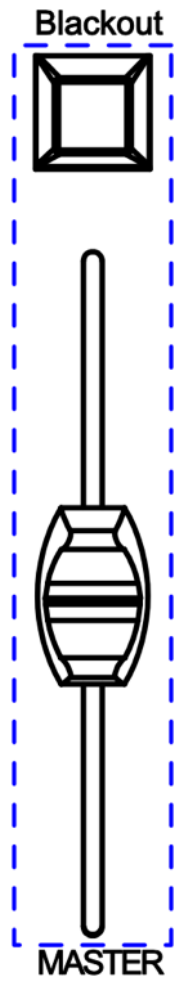

The master fader is used to control the overall level of the stage lights.

USB LED LIGHT

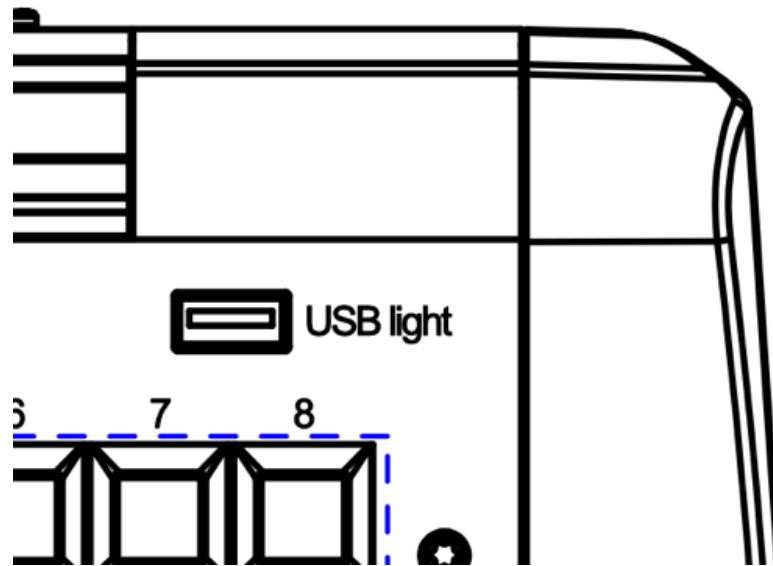

A flexible LED work light is included with the Link controller. It is attached to the top panel of the Link in the upper right where it's labeled "USB Light" as shown in the photo below. The light itself has a touch switch on the top with three brightness settings.

REAR PANEL

The picture below shows the connectors on the back of the Link controller. From left to right are four 5-pin DMX512 outputs, one for each of four DMX512 universes. In the center is the dual band Wi-Fi antenna encased in the small plastic enclosure. To the right of the antenna is the USB connector and the DC power connector. On the far right is a Kensington slot and the power switch.



- 4x Locking 5-pin DMX Sockets

- Dual Band Wi-Fi Antenna

- USB type B connector
- DC Input 9V
- Kensington slot for attaching a security cable
- Power ON/OFF switch

The Link comes with a regulated external power supply that is rated for 1A at 9VDC. Always use a power supply with the equivalent rating and connector size and polarity.

CONNECTING TO THE LINK CONTROLLER

The Link controller connects to your iPad using either its private Wi-Fi network, or the USB connector on the back. When the Link controller is turned on, it will create a local Wi-Fi network that you can join using the Wi-Fi settings on your iPad. The network will show up on the list of available networks in the Wi-Fi section in your iPad's settings. The default network name is "ADJLink". The default password is "link1234". Select and join the network as you would join any other Wi-Fi network from your iPad. ***It is highly recommended that you change the password before using it in public. The network can appear on any Wi-Fi device in the vicinity of your lighting system. As an added security feature only one device can connect to the network.***

If you prefer to use a hardwired connection between the iPad and Link you will need a USB cable adapter. There are several types that will work depending on the iPad model. For an iPad with lightning connector, figures A and B will work. Figure B, which is sometimes referred to as the Apple camera adapter also allows the iPad to connect to a charger at the same time. If you have an iPad Pro with USB C connector, you will need something like Figure C along with a standard USB printer style cable.



Fig. A



Fig. B



Fig. C

There are several advantages to using the wireless connection. Mobility is probably the most helpful as you will be able to carry the iPad to different parts of the room as needed when doing setups or when you want to control the lighting from somewhere other than where the console is located, as long as the iPad is within range of the console's network.

The Wi-Fi range between your iPad and the Link will vary depending on the environment, but you should expect no more than 75 feet for a fast, reliable connection indoors. Walls can shorten the range. The Link Wi-Fi is dual band and its network can run at 5GHz or at 2.4GHz. The band is selected manually from the settings section in the app. 5GHz is the default band and is faster and usually less congested but 2.4GHz usually has longer range and is better at going through walls but is also typically more congested when other networks are in the area. The Link will try to find the least congested Wi-Fi channel for either band when it powers on. Consult the "Settings" chapter in the app-manual on how to select the Wi-Fi band.

RACK MOUNTING HARDWARE

The **LINK™** comes with replacement sides so that you can rack mount it in a standard 19" rack enclosure or case. To install the rack mount hardware, you must remove the plastic end caps, and then reuse the mounting screws to attach the metal rack-mountable sides. Each side requires that you remove a total of (7) screws, (3) on the top, (3) on the bottom, and (1) on the back. Pull the plastic end caps away from the unit and then insert the metal rack mount sides so that the screw holes are aligned properly. The height is 7.5 rack spaces starting from the bottom. This leaves a gap at the top to allow room for the USB cable to fit.

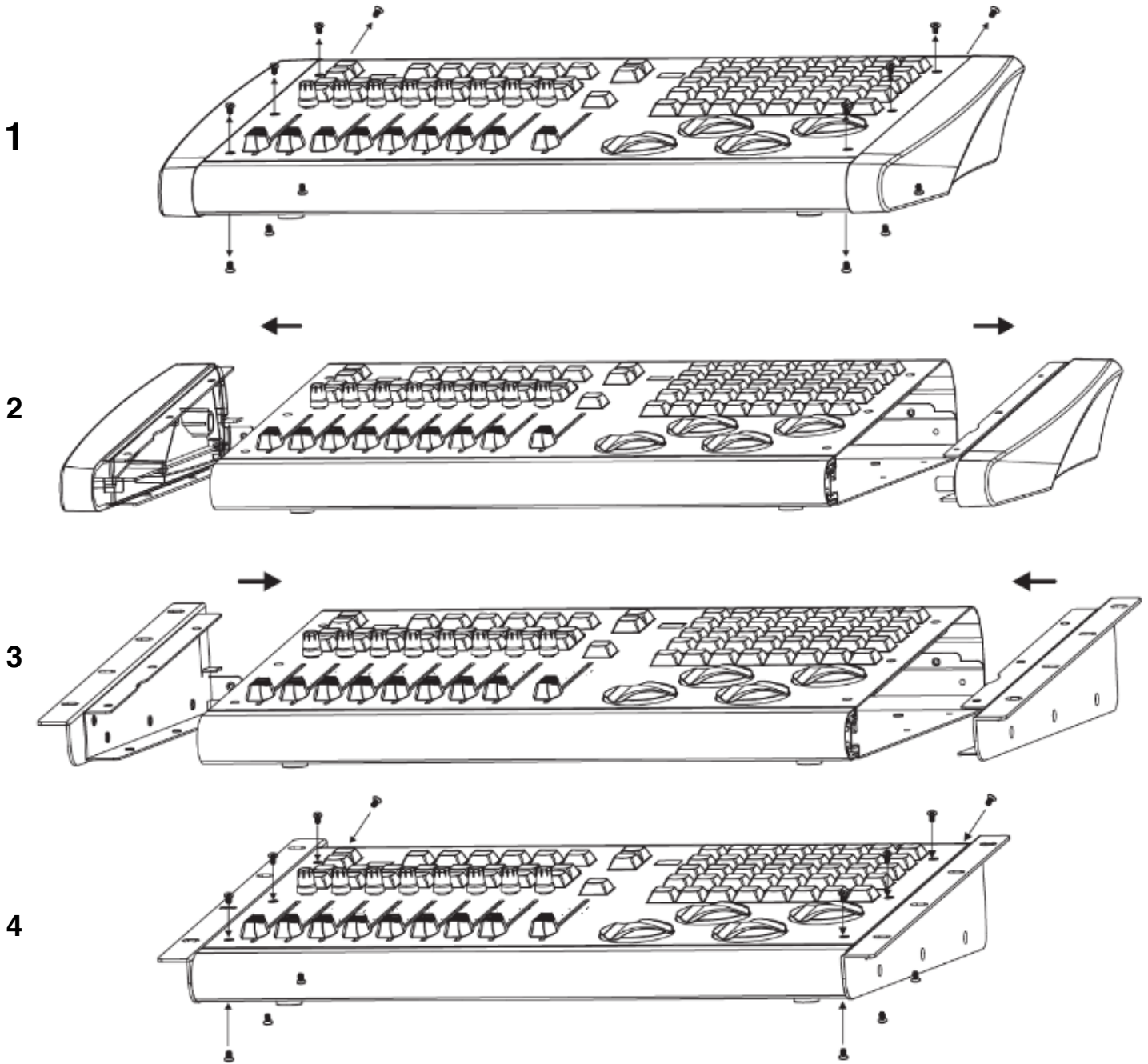

TECHNICAL SPECIFICATIONS

CONTROL / CONNECTIONS:

(11) Shortcut Buttons
(1) Master and (8) Control 100mm Faders
(16) Buttons Above Faders
(8) Rotary Dials with Push-In Selection Above Faders
(1) Blackout Button
(32) Effect or Scene Buttons
(4) Rotary Encoder Wheels with Push-In Selection
(2) Wheel shift buttons
USB 2.0 Type "B" Port

SIZE / WEIGHT:

Length: 20.3" (514mm)
Width: 13.2" (336mm)
Vertical Height: 3.5" (88mm)
Weight: 13.0 LBS. (5.9 kg)

INCLUDED ITEMS:

USB Cable
USB Light
DC9V Power Supply
Rack Mount Kit

ADDITIONAL FEATURES:

Wi-Fi and USB compatible
2.4 and 5Ghz GHz Wi-Fi Network
4 DMX Universes
USB Input for Gooseneck Work Light
Removable Outer Case for 6U Rack Mounting
Kensington™ Security Device Slot

Specifications and documentation subject to change without notice.

DIMENSIONAL DRAWINGS – PLASTIC SIDES

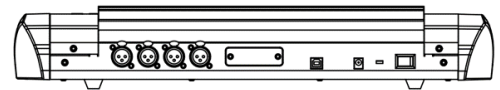
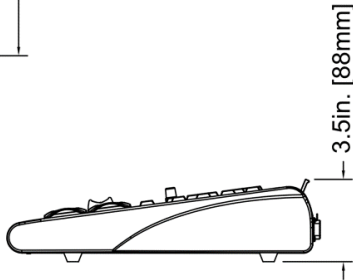
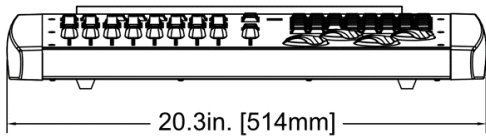
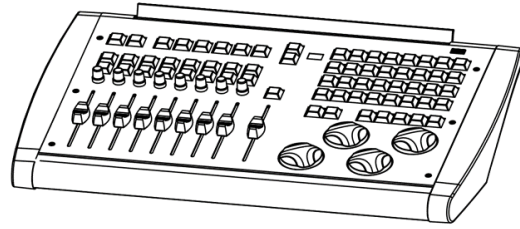
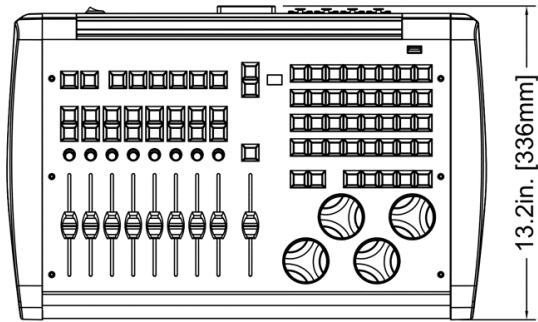

DIMENSIONAL DRAWINGS – RACK MOUNT SIDES

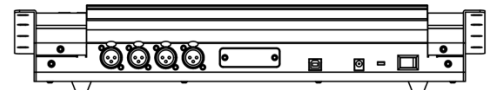
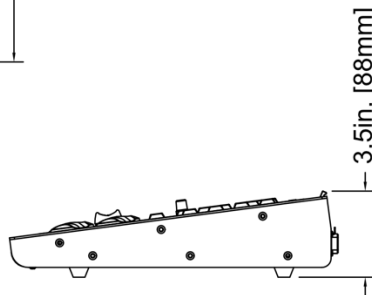
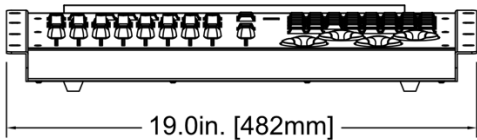
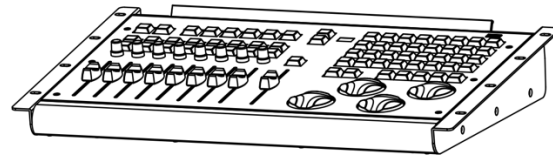
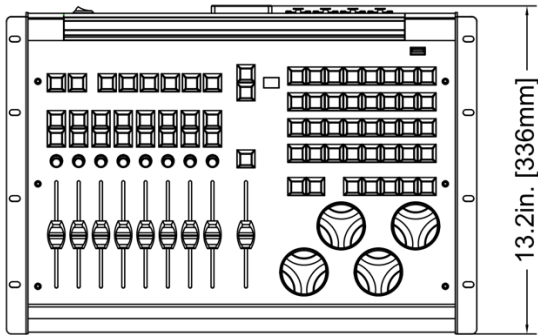

FCC Compliance Statement

This device complies with Part 15 of the FCC Rules. Operation is subject to the following two conditions: (1) this device may not cause harmful interference, and (2) this device must accept any interference received, including interference that may cause undesired operation.

FCC Warning

NOTE: This equipment has been tested and found to comply with the limits for a Class A digital device, pursuant to part 15 of the FCC Rules. These limits are designed to provide reasonable protection against harmful interference when the equipment is operated in a commercial environment. This equipment generates, uses, and can radiate radio frequency energy and, if not installed and used in accordance with the instruction manual, may cause harmful interference to radio communications. Operation of this equipment in a residential area is likely to cause harmful interference in which case the user will be required to correct the interference at his own expense.

