



# JOLT BAR FX

User Manual

©2023 ADJ Products, LLC all rights reserved. Information, specifications, diagrams, images, and instructions herein are subject to change without notice. ADJ Products, LLC logo and identifying product names and numbers herein are trademarks of ADJ Products, LLC. Copyright protection claimed includes all forms and matters of copyrightable materials and information now allowed by statutory or judicial law or hereinafter granted. Product names used in this document may be trademarks or registered trademarks of their respective companies and are hereby acknowledged. All non-ADJ Products, LLC brands and product names are trademarks or registered trademarks of their respective companies.

**ADJ Products, LLC** and all affiliated companies hereby disclaim any and all liabilities for property, equipment, building, and electrical damages, injuries to any persons, and direct or indirect economic loss associated with the use or reliance of any information contained within this document, and/or as a result of the improper, unsafe, insufficient and negligent assembly, installation, rigging, and operation of this product.

**ADJ PRODUCTS LLC World Headquarters**

6122 S. Eastern Ave. | Los Angeles, CA 90040 USA

Tel: 800-322-6337 | Fax: 323-582-2941 | [www.adj.com](http://www.adj.com) | [lsupport@adj.com](mailto:lsupport@adj.com)

**ADJ Supply Europe B.V.**

Junostraat 2 | 6468 EW Kerkrade | Netherlands

Tel: +31 45 546 85 00 | Fax: +31 45 546 85 99 | [www.americandj.eu](http://www.americandj.eu) | [service@americandj.eu](mailto:service@americandj.eu)

**Europe Energy Saving Notice**

Energy Saving Matters (EuP 2009/125/EC)

Saving electric energy is a key to help protecting the environment. Please turn off all electrical products when they are not in use. To avoid power consumption in idle mode, disconnect all electrical equipment from power when not in use. Thank you!

**DOCUMENT VERSION**



Due to additional product features and/or enhancements, an updated version of this document may be available online.

Please check [www.adj.com](http://www.adj.com) for the latest revision/update of this manual before beginning installation and/or programming.

Date	Document Version	Software Version	DMX Channels	Notes
01/24/2022	1.0	1.0	6/9/13/16/18/32/38/ 42/64/112/126	Initial Release
03/04/2022	1.1	1.0	6/9/13/16/18/32/38/ 43/64/112/127	Corrected System Menu, DMX Traits, and Specifications
10/20/2022	1.2	1.0	No Change	Updated Dimensions
11/28/2022	1.3	N/C	No Change	Added FCC, Updated Power Consumption
12/29/2022	1.4	1.2	6/9/13/16/18/32/32A/ 38/43/64/112/127	Updated System Menu, DMX Traits, Specifications
02/03/2023	1.5	N/C	No Change	Corrected LED Pixel Zones; updated RDM

# CONTENTS

Introduction	4
Limited Warranty (USA Only)	5
Warranty Registration   Features	6
Safety Guidelines	7
Overview	8
Installation	9
Remove Device Management	12
Control Panel	13
System Menu	14
DMX Setup	17
DMX Traits	19
LED Pixel Zones	25
Dimmer Modes and Curves	26
Daisy Chain Power Linking   Cleaning and Maintenance	27
Dimensional Drawings	28
Specifications	29
FCC Compliance	30

# GENERAL INFORMATION

## INTRODUCTION

Please read and understand the instructions in this manual carefully and thoroughly before attempting to operate this device. These instructions contain important safety and use information.

**This product is intended for use by professionally trained personnel only, and is not suitable for private use.**

## Unpacking

Every device has been thoroughly tested and has been shipped in perfect operating condition. Carefully check the shipping carton for damage that may have occurred during shipping. If the carton is damaged, carefully inspect the device for damage, and be sure all accessories necessary to install and operate the device have arrived intact. In the event damage has been found or parts are missing, please contact our customer support team for further instructions. Please do not return this device to your dealer without first contacting customer support. Please do not discard the shipping carton in the trash. Please recycle whenever possible.

## BOX CONTENTS

Omega Brackets  
1.83M locking power cable

## CUSTOMER SUPPORT

Contact ADJ Service for any product related service and support needs.  
Also visit [forums.adj.com](https://forums.adj.com) with questions, comments or suggestions.

**ADJ SERVICE USA** - Monday - Friday 8:00am to 4:30pm PST  
323-582-2650 | Fax: 323-832-2941 | [support@adj.com](mailto:support@adj.com)

**ADJ SERVICE EUROPE** - Monday - Friday 08:30 to 17:00 CET  
+31 45 546 85 60 | Fax: +31 45 546 85 96 | [support@adj.eu](mailto:support@adj.eu)

**REPLACEMENT PARTS** please visit [parts.adj.com](https://parts.adj.com)



## IMPORTANT NOTICE!

**THERE ARE NO USER SERVICEABLE PARTS INSIDE THIS UNIT.  
DO NOT ATTEMPT ANY REPAIRS YOURSELF; DOING SO WILL VOID YOUR MANUFACTURER'S WARRANTY. DAMAGES RESULTING FROM MODIFICATIONS TO THIS FIXTURE AND/OR THE DISREGARD OF SAFETY INSTRUCTIONS AND GUIDELINES IN THIS MANUAL VOID THE MANUFACTURER'S WARRANTY AND ARE NOT SUBJECT TO WARRANTY CLAIMS AND/OR REPAIRS.**

# LIMITED WARRANTY (USA ONLY)

- A. ADJ Products, LLC hereby warrants, to the original purchaser, ADJ Products, LLC products to be free of manufacturing defects in material and workmanship for a prescribed period from the date of purchase (see specific warranty period on reverse). This warranty shall be valid only if the product is purchased within the United States of America, including possessions and territories. It is the owner's responsibility to establish the date and place of purchase by acceptable evidence, at the time service is sought.
- B. For warranty service, you must obtain a Return Authorization number (RA#) before sending back the product-please contact ADJ Products, LLC Service Department at 800-322-6337. Send the product only to the ADJ Products, LLC factory. All shipping charges must be pre-paid. If the requested repairs or service (including parts replacement) are within the terms of this warranty, ADJ Products, LLC will pay return shipping charges only to a designated point within the United States. If the entire instrument is sent, it must be shipped in its original package. No accessories should be shipped with the product. If any accessories are shipped with the product, ADJ Products, LLC shall have no liability whatsoever for loss of or damage to any such accessories, or for the safe return thereof.
- C. This warranty is void if the serial number has been altered or removed; if the product is modified in any manner which ADJ Products, LLC concludes, after inspection, affects the reliability of the product, if the product has been repaired or service by anyone other than ADJ Products, LLC factory unless prior written authorization was issued to purchaser by ADJ Products, LLC; if the product is damaged because not properly maintained as set forth in the instruction manual.
- D. This is not a service contract, and this warranty does not include maintenance, cleaning or periodic check up. During the period specified above, ADJ Products, LLC will replace defective parts at its expense with new or refurbished parts, and will absorb all expenses for warranty service and repair labor by reason of defects in material or workmanship. The sole responsibility of ADJ Products, LLC under this warranty shall be limited to the repair of the product, or replacement thereof, including parts, at the sole discretion of ADJ Products, LLC. All products covered by this warranty were manufactured after August 15, 2012, and bear identifying marks to that effect.
- E. ADJ Products, LLC reserves the right to make changes in design and/or improvements upon its products without any obligation to include these changes in any products theretofore manufactured.
- F. No warranty, whether expressed or implied, is given or made with respect to any accessory supplied with products described above. Except to the extent prohibited by applicable law, all implied warranties made by ADJ Products, LLC in connection with this product, including warranties of merchantability or fitness, are limited in duration to the warranty period set forth above. And no warranties, whether expressed or implied, including warranties of merchantability or fitness, shall apply to this product after said period has expired. The consumer's and/or Dealer's sole remedy shall be such repair or replacement as is expressly provided above; and under no circumstances shall ADJ Products, LLC be liable for any loss or damage, direct or consequential, arising out of the use of, or inability to use, this product.
- G. This warranty is the only written warranty applicable to ADJ Products, LLC Products and supersedes all prior warranties and written descriptions of warranty terms and conditions heretofore published.

## LIMITED WARRANTY PERIODS

- **Non L.E.D. Lighting Products = 1-year (365 days) Limited Warranty** (Such as: Special Effect Lighting, Intelligent Lighting, UV lighting, Strobes, Fog Machines, Bubble Machines, Mirror Balls, Par Cans, Trussing, Lighting Stands etc. excluding LED and lamps)
- **Laser Products = 1 Year (365 Days) Limited Warranty** (excludes laser diodes which have 6 month limited warranty)
- **L.E.D. Products = 2-year (730 days) Limited Warranty** (excluding batteries which have a 180 day limited warranty)  
Note: 2 Year Warranty only applies to purchases within the United States.
- **StarTec Series = 1 Year Limited Warranty** (excluding batteries which have a 180 day limited warranty)
- **ADJ DMX Controllers = 2 Year (730 Days) Limited Warranty**

# WARRANTY REGISTRATION

The Jolt Bar FX carries a 2 year limited warranty. Please fill out the enclosed warranty card to validate your purchase. All returned service items, whether under warranty or not, must be freight pre-paid and accompanied by a return authorization (R.A.) number. The R.A. number must be clearly written on the outside of the return package. A brief description of the problem as well as the R.A. number must also be written down on a piece of paper included in the shipping carton. If the unit is under warranty, you must provide a copy of your proof of purchase invoice. You may obtain an R.A. number by contacting our customer support team on our customer support number. All packages returned to the service department not displaying an R.A. number on the outside of the package will be returned to the shipper.

## FEATURES

The ADJ Jolt Bar FX is a professional linear LED fixture that delivers lighting designers huge output as well as the creative potential of brilliant bright white strobe/blinder LEDs combined with multi-colored chase effects in one versatile unit. Ideal for concert productions, festival stages and rental houses, as well as for permanent installation in large nightclubs, the Jolt Bar FX is a flexible fixture that can be used to create a wide variety of effects.

- 32 x RGB LED zones with individual control
- 16 X Cool White LED zones with individual control
- Color mixing effect
- Strobe effect with variable speed
- Smooth dimming from 0% to 100%
- Double mounting brackets with 180-degree adjustability

### INCLUDED ITEMS:

- 1 x Locking power cable

### IP RATING

This device is IP20 rated. This means that the unit is protected against the intrusions of solids approximately the size of an adult finger (2.5mm) or larger, but **the unit is not protected against water or liquid intrusion of any kind.**

# SAFETY GUIDELINES

**THIS FIXTURE IS COMPOSED OF SOPHISTICATED ELECTRONIC COMPONENTS. TO GUARANTEE SMOOTH OPERATION, IT IS IMPORTANT TO FOLLOW ALL INSTRUCTIONS AND GUIDELINES IN THIS MANUAL. ADJ PRODUCTS, LLC IS NOT RESPONSIBLE FOR INJURY AND/OR DAMAGES RESULTING FROM THE MISUSE OF THIS FIXTURE DUE TO THE DISREGARD OF THE INFORMATION PRINTED IN THIS MANUAL. ONLY QUALIFIED AND/OR CERTIFIED PERSONNEL SHOULD PERFORM INSTALLATION OF THIS FIXTURE AND ONLY THE ORIGINAL RIGGING PARTS INCLUDED WITH THIS FIXTURE SHOULD BE USED FOR INSTALLATION. ANY MODIFICATIONS TO THE FIXTURE AND/OR THE INCLUDED MOUNTING HARDWARE WILL VOID THE ORIGINAL MANUFACTURER'S WARRANTY AND INCREASE THE RISK OF DAMAGE AND/OR PERSONAL INJURY. ONLY CERTIFIED PERSONNEL SHOULD PERFORM INSTALLATION OF THIS FIXTURE.**

- PROTECTION CLASS 1 - FIXTURE MUST BE PROPERLY GROUNDED.
- THERE ARE NO USER SERVICEABLE PARTS INSIDE THIS UNIT.
- DO NOT ATTEMPT ANY REPAIRS YOURSELF; DOING SO WILL VOID YOUR MANUFACTURER'S WARRANTY. DAMAGES RESULTING FROM MODIFICATIONS TO THIS FIXTURE AND/OR THE DISREGARD OF SAFETY INSTRUCTIONS AND GUIDELINES IN THIS MANUAL VOID THE MANUFACTURER'S WARRANTY AND ARE NOT SUBJECT TO ANY WARRANTY CLAIMS AND/OR REPAIRS.
- DO NOT PLUG FIXTURE INTO A DIMMER PACK!
- NEVER OPEN THIS FIXTURE WHILE IN USE!
- UNPLUG POWER BEFORE SERVICING FIXTURE!
- NEVER TOUCH FIXTURE DURING OPERATION, AS IT MAY BE HOT!
- KEEP FLAMMABLE MATERIALS AWAY FROM FIXTURE!
- NEVER LOOK DIRECTLY INTO THE LIGHT SOURCE!
- RETINA INJURY RISK - MAY INDUCE BLINDNESS!
- SENSITIVE PERSONS MAY SUFFER AN EPILEPTIC SHOCK!
- INDOOR / DRY LOCATIONS USE ONLY!
- DO NOT EXPOSE FIXTURE TO RAIN AND MOISTURE!
- MINIMUM DISTANCE TO OBJECTS/SURFACES IS 6.6 FEET (2 METERS)
- MINIMUM DISTANCE TO FLAMMABLE MATERIALS FROM THE SURFACE IS 1.6 FEET (0.5 METER).
- DO NOT TOUCH the fixture housing during operation. Turn OFF the power and allow approximately 60 minutes for the fixture to cool down before serving.
- DO NOT shake fixture, and avoid brute force when installing and/or operating fixture.
- DO NOT operate fixture if the power cord is frayed, crimped, damaged and/or if any of the power cord connectors are damaged and do not insert into the fixture securely with ease. NEVER force a power cord connector into the fixture. If the power cord or any of its connectors are damaged, replace it immediately with a new one of the same power rating.
- DO NOT block any air ventilation slots. All fan and air inlets must remain clean and never blocked. Allow approx. 6" (15cm) between fixture and other devices or a wall for proper cooling.
- When installing fixture in a suspended environment, always use mounting hardware that is no less than M10 x 25 mm, and always install fixture with an appropriately rated safety cable.
- Always disconnect fixture from main power source before performing any type of service and/or cleaning procedure.
- Only handle the power cord by the plug end. Never pull out the plug by tugging the wire portion of the cord.
- During the initial operation of this fixture, a light smoke or smell may emit from the interior of the fixture. This is a normal process and is caused by excess paint in the interior of the casing burning off from the heat associated with the lamp and will decrease gradually over time.
- Consistent operational breaks will ensure fixture will function properly for many years.
- Only use original packaging and materials to transport the fixture in for service.

# OVERVIEW

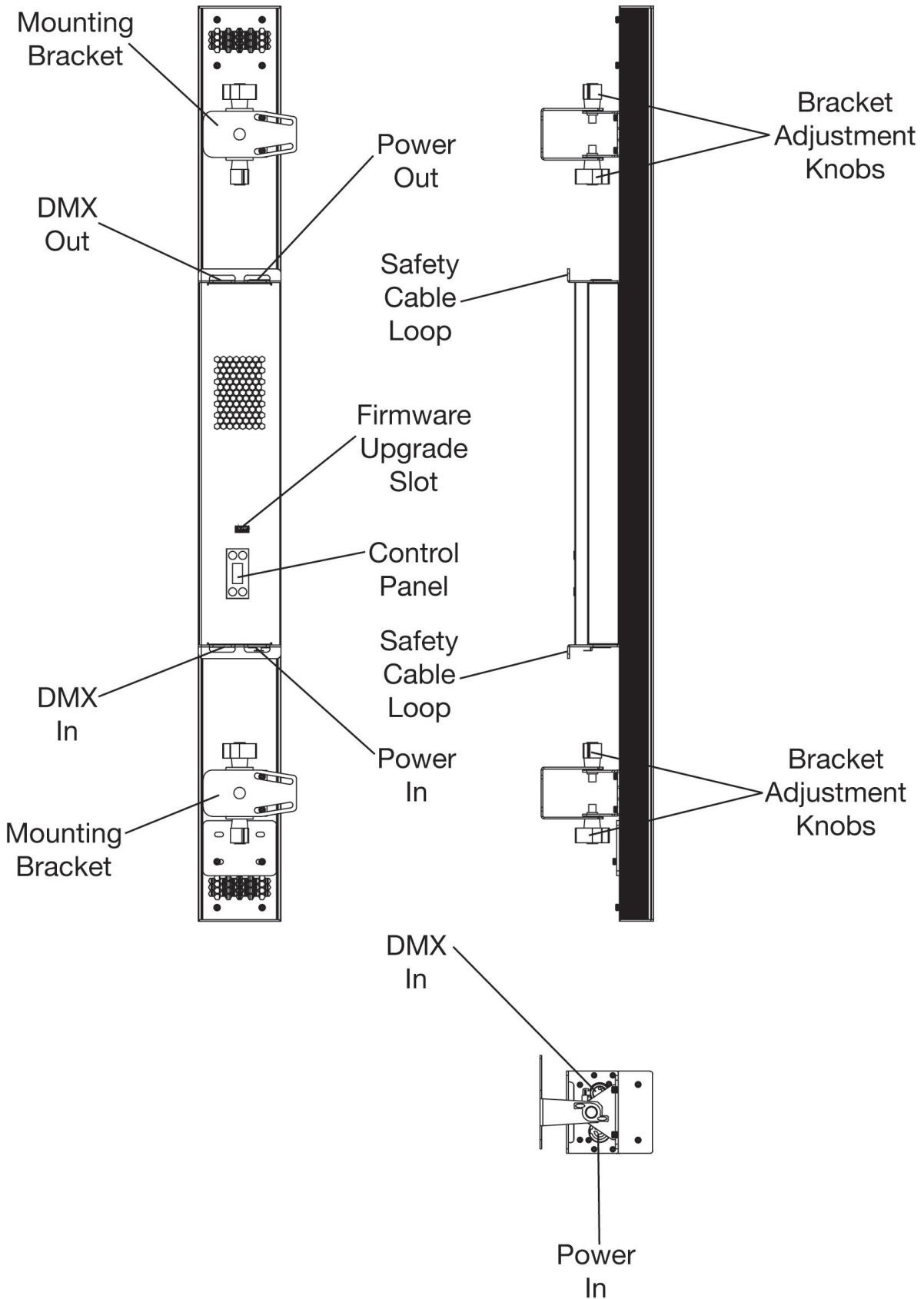



# INSTALLATION



## **FLAMMABLE MATERIAL WARNING**

Keep fixture minimum 5.0 feet (1.5m) away from flammable materials and/or pyrotechnics.



## **ELECTRICAL CONNECTIONS**

A qualified electrician should be used for all electrical connections and/or installations.



**MINIMUM DISTANCE TO OBJECTS/SURFACES IS 6.6 FEET (2 METERS).**

**MINIMUM DISTANCE OF INFLAMMABLE MATERIALS FROM THE SURFACE IS 1.6 FEET (0.5 METERS).**

## **DO NOT INSTALL THE FIXTURE IF YOU ARE NOT QUALIFIED TO DO SO!**

- Fixture **MUST** be installed following all local, national, and country commercial electrical and construction codes and regulations.
- Before rigging/mounting a single fixture or multiple fixtures to any metal truss/structure or placing the fixture(s) on any surface, a professional equipment installer **MUST** be consulted to determine if the metal truss/structure or surface is properly certified to safely hold the combined weight of the fixture(s), clamps, cables, and accessories.
- Maximum ambient operating temperature is **113°F (45°C)**. Do not use fixture when ambient temperature exceeds this value.
- Fixture(s) should be installed outside walking paths, seating areas, or areas where unauthorized personnel might reach the fixture by hand.
- **NEVER** stand directly below the fixture(s) when rigging, removing, or servicing.
- Overhead fixture installation must always be secured with a secondary safety attachment, such as an appropriately rated safety cable.
- Allow approximately 60 minutes for the fixture to cool down before servicing.

## **IP RATING**

**This device is IP20 rated. This means that the unit is protected against the intrusion of solids 2.5mm in size or larger (approximately the size of an adult finger tip). The unit is NOT protected against water or liquid intrusion of any kind!**

## **RIGGING**

**Overhead rigging requires extensive experience, including calculating working load limits, knowledge of installation material being used, and periodic safety inspection of all installation material and the fixture, among other skills. If you lack these qualifications, do not attempt the installation yourself. Improper installation can result in bodily injury.**

# INSTALLATION

## CLAMP INSTALLATION

This fixture features a mounting point on the yoke for the attachment of a mounting clamp. There is also a safety cable loop located on the rear of the fixture (see the illustration below). When mounting the fixture to a truss or any other suspended or overhead installation, be sure to secure appropriately rated clamps (not included) to the yoke, and attach a separate SAFETY CABLE of the appropriate weight rating to the safety cable loop.

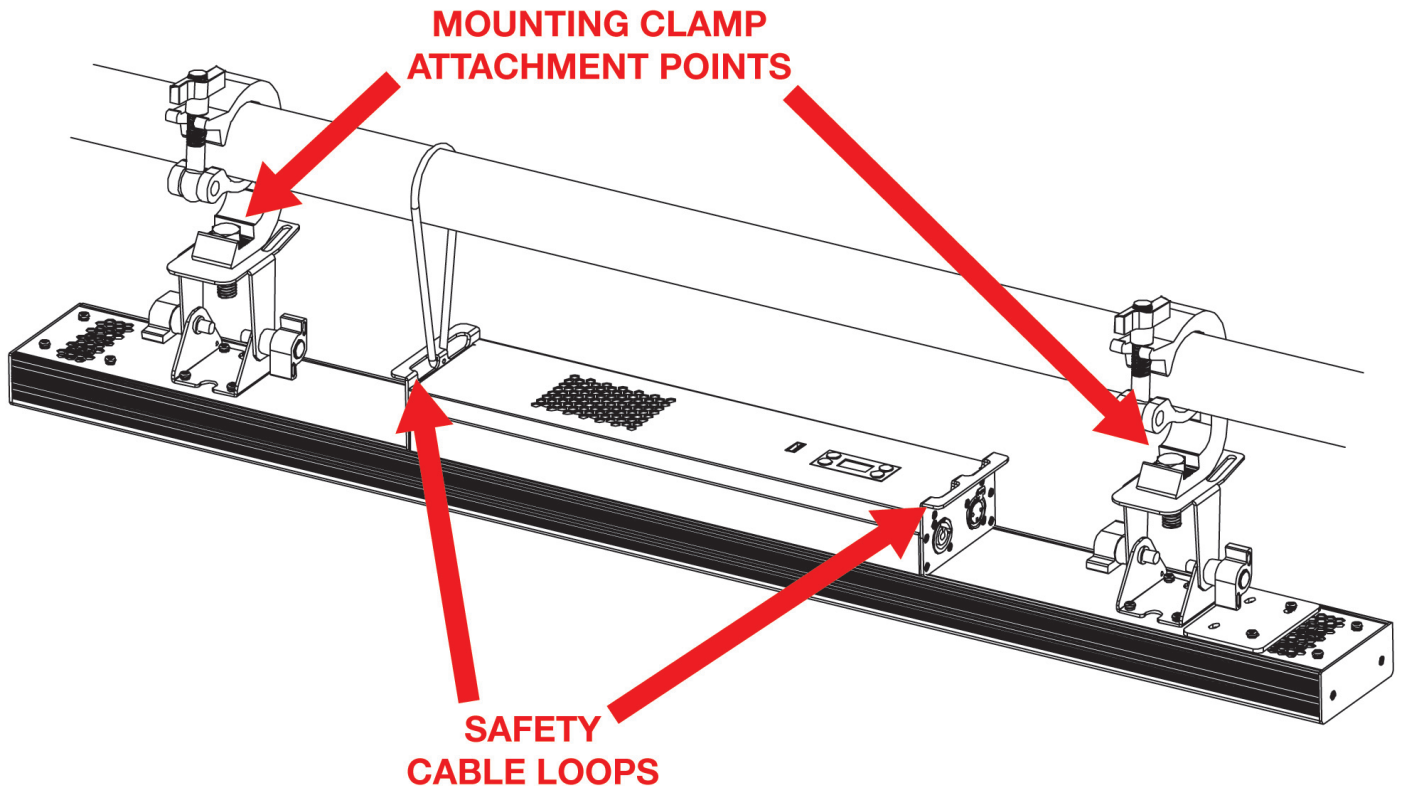

### SAFETY CABLE:

**ALWAYS ATTACH A SAFETY CABLE WHENEVER INSTALLING THIS FIXTURE IN A SUSPENDED ENVIRONMENT TO ENSURE THAT THE FIXTURE WILL NOT FALL IF THE CLAMPS FAIL.**

# INSTALLATION

## CONNECTOR PLATE:

Each unit includes a connector plate that can be used to secure two adjacent mounted units together. To install the connector plate, follow the directions below:

1. Locate the connector plate. It is affixed to back of the unit, near one of the ends of the bar. See the illustrations below for guidance.

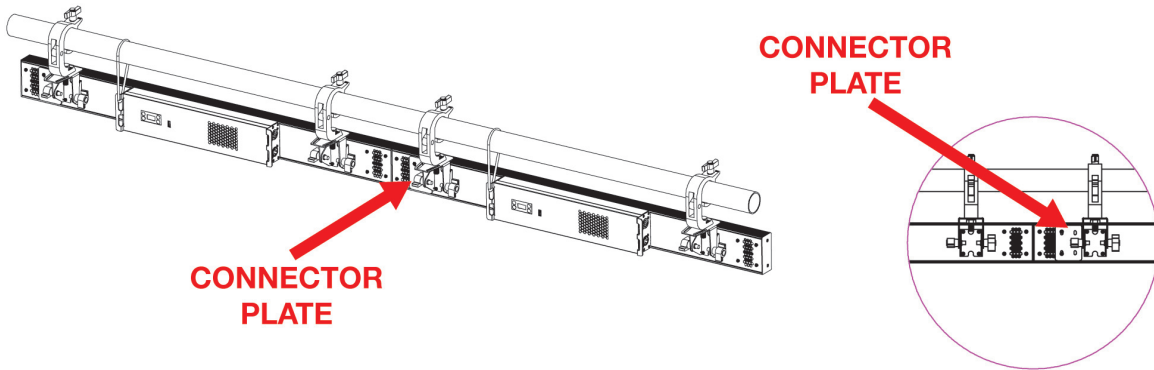

2. Remove the two (2) screws holding the connector plate in place, as well as two (2) screws on the end of each adjacent unit, for a total of six (6) screws. Remove the connector plate.

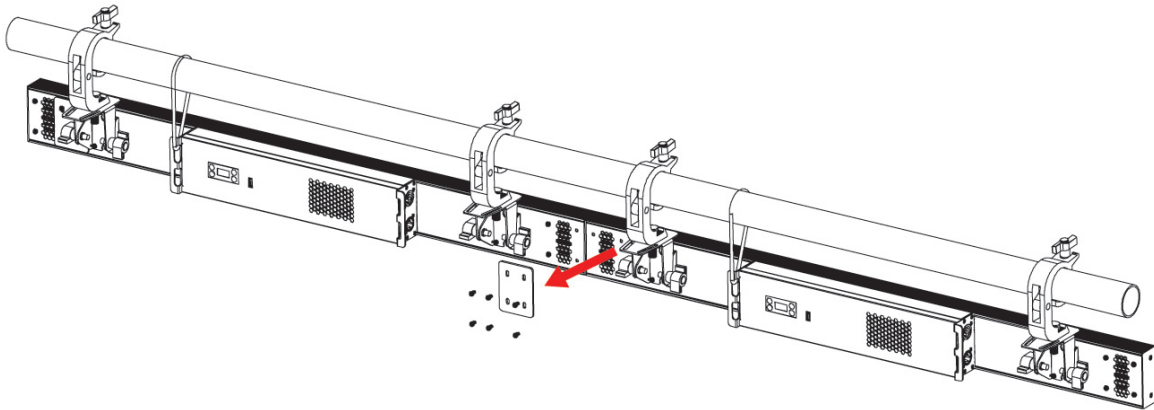

3. Place the connector plate across the gap between the two units, making sure to align the plate with the four (4) screw holes. Reinstall the four (4) screws that secure the connector plate in place, as well as the two (2) additional screws that held the connector plate in its storage position. The installation is now complete.

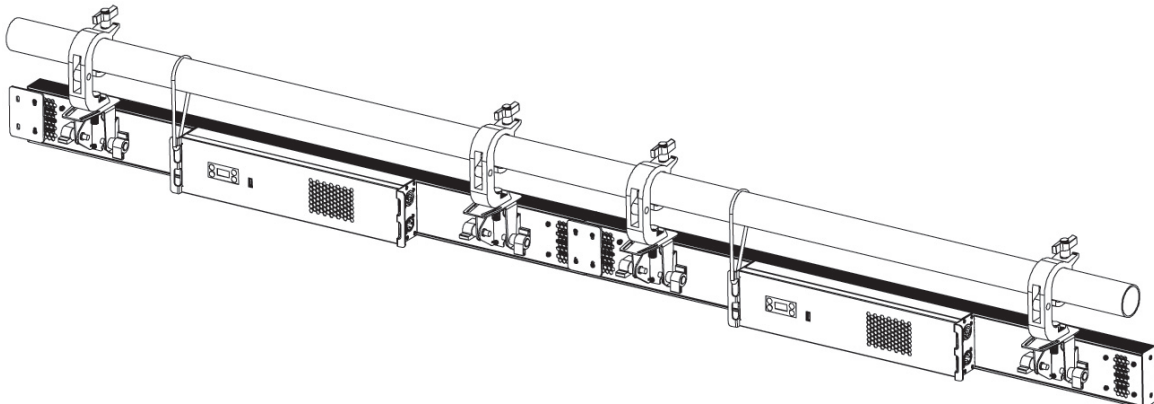

# REMOTE DEVICE MANAGEMENT

**NOTE: In order for RDM to work properly, RDM enabled equipment must be used throughout the entire system, including DMX data splitters and wireless systems.**

Remote Device Management (RDM) is a protocol that sits on top of the DMX512 data standard for lighting, and allows the DMX systems of the fixtures to be modified and monitored remotely. This protocol is ideal for instances in which a unit is installed in a location that is not easily accessible.

With RDM, the DMX512 system becomes bi-directional, allowing a compatible RDM enabled controller to send out a signal to devices on the wire, as well as allowing the fixture to respond (known as a GET command). The controller can then use its SET command to modify settings that would typically have to be changed or viewed directly via the unit's display screen, including the DMX Address, DMX Channel Mode, and Temperature Sensors.

## RDM FIXTURE INFORMATION:

RDM Code	Device ID	Device Model ID	Personality ID
0x1900	Random	0x1FDC	0x010A (6CH), 0x020A (9CH), 0x030A (13CH), 0x040A (16CH), 0x050A (18CH), 0x060A (32CH), 0x070A (38CH), 0x080A (43CH) 0x090A (64CH), 0x0A0A (112CH), 0x0B0A (127CH)

**Please be aware that not all RDM devices support all RDM features, and therefore it is important to check beforehand to ensure that the equipment that you are considering includes all of the features that you require.**

The following parameters are accessible in RDM on this device:

[0x0200] Sensor Definition
[0x0201] Sensor Value
[0x0080] Device Model Description
[0x0081] Manufacturer Label
[0x0082] Device Label
[0x00E0] DMX Personality
[0x00E1] DMX Personality Description
[0x0400] Device Hours
[0x0600] Pan Invert
[0x0601] Tilt Invert
[0x0500] Display Invert

# CONTROL PANEL

The fixture includes an easy to navigate system menu control panel display where all necessary settings and adjustments are made.

- **MENU:** Leave current menu and return to previous menu level.
- **UP:** Scroll up in currently displayed menu.
- **DOWN:** Scroll down in currently displayed menu.
- **ENTER:** Select an option or confirm a selection.

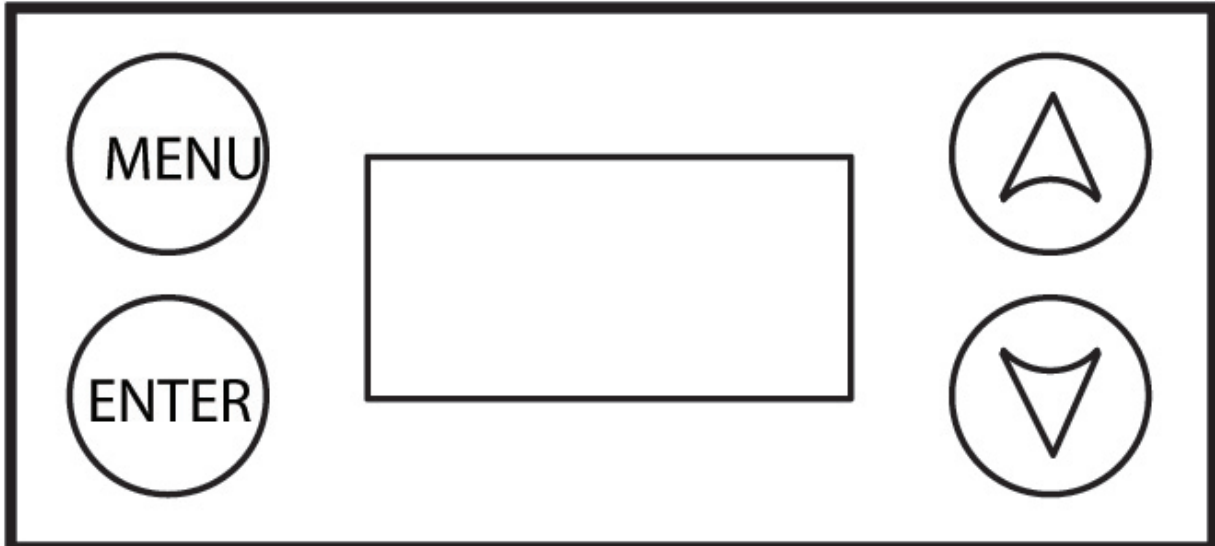

This fixture includes a display lock feature which automatically shuts off the display screen after a certain period of inactivity. This feature is OFF by default, which means that the display will always remain on regardless of inactivity, but can be configured to kick in after up to 10 minutes of inactivity. See the **System Menu** section of this manual for details on how to configure this setting.

# SYSTEM MENU

<b>DMX SETTINGS</b>	DMX Address	1 - 507 (6ch)	
		1 - 504 (9ch)	
		1 - 500 (13ch)	
		1 - 497 (16ch)	
		1 - 495 (18ch)	
		1 - 481 (32ch)	
		<b>1 - 481 (32Ach)</b>	
		1 - 475 (38ch)	
		1 - 470 (43ch)	
		1 - 449 (64ch)	
		1 - 401 (112ch)	
		1 - 386 (127ch)	
		DMX Channel Mode	6CH
	9CH		
	13CH		
	16CH		
	18CH		
	32CH		
	<b>32Ach</b>		
	38CH		
	43CH		
	64CH		
	112CH		
	127CH		
	No DMX Status	Blackout	Takes all traits to 0 when DMX signal is lost or interrupted.
<b>Hold</b>		Holds all traits at last received value when DMX signal is lost or interrupted.	
Manual		Defaults to values set in Manual Mode when DMX signal is lost or interrupted.	

CONTINUED ON NEXT PAGE

# SYSTEM MENU

<b>PERSONALITY</b>	Dim Modes	<b>Standard</b>			
		Stage			
		TV			
		Architectural			
		Theatre			
		Stage 2			
	Dimmer Curve	Linear			
		<b>Square</b>			
		Inv. Sq.			
		S-Curve			
	Display	Display Backlight	<b>Off</b> - 2 min		
		Display Lock	<b>Off</b> - 10 min		
		Display Invert	<b>No</b> / Yes		
	Temperature Unit	°C / °F			
	Fan Speed	Low			
		<b>High</b>			
		Auto			
	Service (Passcode = 011)	White Balance	Red1 (000 - <b>255</b> )		
			Green1 (000 - <b>255</b> )		
			Blue1 (000 - <b>255</b> )		
White1 (000 - <b>255</b> )					
Red2 (000 - <b>255</b> )					
Green2 (000 - <b>255</b> )					
Blue2 (000 - <b>255</b> )					
White2 (000 - <b>255</b> )					
...					
USB Port Power		On / <b>Off</b>			
Update Software		Yes / <b>No</b>			
Factory Restore	Yes / <b>No</b>				
<b>MANUAL</b>	Red1	000 - 255		Note: Manual control settings shall always hold when no DMX signal is detected.	
	Green1	000 - 255			
	Blue1	000 - 255			
	White1	000 - 255			
	Red2	000 - 255			
	Green2	000 - 255			

CONTINUED ON NEXT PAGE

# SYSTEM MENU

<b>MANUAL (continued)</b>	Blue2	000 - 255		Note: Manual control settings shall always hold when no DMX signal is detected.
	White2	000 - 255		
	...	...		
	Strobe Effect	000 - 255		
	Strobe Rate	000 - 255		
	Strobe Duration	000 - 255		
	...	...		
	Dimmer Fine	000 - 255		
<b>FIXTURE TEST</b>	Auto Test			
<b>FIXTURE INFORMATION</b>	Fixture Use Hour			
	LED Use Hour	Total LED Hour		
		LED On Hour		
		LED Hours Reset	Passcode = 011	
	Temperature			
	Fan State			
	RDM UID	xxxxxx		
	Error Logs	Fixture Errors		
		Reset Error Log (Passcode = 011)	<b>No / Yes</b>	
	Firmware Version	x.xx		



# DMX SETUP

**DMX-512:** DMX is short for Digital Multiplex. This is a universal protocol used as a form of communication between intelligent fixtures and controllers. A DMX controller sends DMX data instructions from the controller to the fixture. DMX data is sent as serial data that travels from fixture to fixture via the DATA “IN” and DATA “OUT” XLR terminals located on all DMX fixtures (most controllers only have a DATA “OUT” terminal).

**DMX Linking:** DMX is a language allowing all makes and models of different manufacturers to be linked together and operate from a single controller, as long as all fixtures and the controller are DMX compliant. To ensure proper DMX data transmission, try to use the shortest cable path possible when using several DMX fixtures. The order in which fixtures are connected in a DMX line does not influence the DMX addressing. For example, a fixture assigned a DMX address of 1 may be placed anywhere in a DMX line: at the beginning, at the end, or anywhere in the middle. When a fixture is assigned a DMX address of 1, the DMX controller knows to send DATA assigned to address 1 to that unit, no matter where it is located in the DMX chain.

**Data Cable (DMX Cable) Requirements (For DMX Operation):**The Jolt Panel FX can be controlled via DMX-512 protocol, and features multiple DMX channel modes. Your unit and your DMX controller require a 5-pin XLR connector for data input and data output. If you are making your own cables, be sure to use standard 110-120 Ohm shielded cable (This cable may be purchased at almost all pro lighting stores). Your cables should be made with a male XLR connector at one end and a female XLR connector on the other. Also remember that DMX cable must be daisy chained and cannot be split.

**Special Note:** Line Termination. When longer runs of cable are used, you may need to use a terminator on the last unit to avoid erratic behavior. A terminator is a 110-120 ohm 1/4 watt resistor which is connected between pins 2 and 3 of a male XLR connector (DATA + and DATA -). This unit is inserted in the female XLR connector of the last unit in your daisy chain to terminate the line. Using a cable terminator (ADJ part number Z-DMX/T) will decrease the chances of erratic behavior.

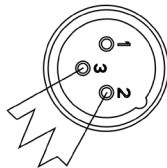
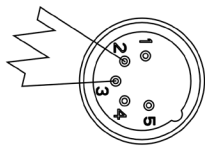

A DMX512 terminator reduces signal errors, avoiding most signal reflection interference. Connect PIN 2 (DMX-) and PIN 3 (DMX+) of the last fixture in series with a 120 Ohm, 1/4 W Resistor to terminate the DMX512.

# DMX SETUP

## DMX ADDRESSING

All fixtures should be given a DMX starting address when operating with a DMX controller, in order to ensure that the correct fixture responds to the correct control signal. This digital starting address is the channel number from which the fixture starts to “listen” to the digital control signal sent out from the DMX controller. The assignment of this starting DMX address is achieved by setting the correct DMX address on the digital control display on the fixture.

You can set the same starting address for all fixtures or a group of fixtures, or set different addresses for each individual fixture. Setting all fixtures to the same DMX address will cause all fixtures to react in the same way. In this case, please note that changing the settings of one channel will affect all the fixtures simultaneously.

If you set each fixture to a different DMX address, each unit will “listen” starting at the channel number you have set, based on the quantity of DMX channels of each fixture. That means changing the settings of one channel will only affect the selected fixture.

As an example, when operating this device in 6 channel mode, you should set the starting DMX address of the first unit to 1, the second unit to 7 (1 + 6), the third unit to 13 (1 + 6 + 6), and so on. (See the chart below for more details.)

Channel Mode	Unit 1 Address	Unit 2 Address	Unit 3 Address	Unit 4 Address
6 Channels	1	7	13	19
9 Channels	1	10	19	28
13 Channels	1	14	27	40
16 Channels	1	17	33	49
18 Channels	1	19	37	55
32 / 32A Channels	1	33	65	97
38 Channels	1	39	77	115
43 Channels	1	44	87	130
64 Channels	1	65	129	193
112 Channels	1	113	225	337

# DMX TRAITS

CHANNEL												DMX VALUES	FUNCTION
6 CH	9 CH	13 CH	16 CH	18 CH	32 CH	32A CH	38 CH	43 CH	64 CH	112 CH	127 CH		
1	1	1		1								000 - 255	<b>Outer Red</b> , 0% to 100%
2	2	2		2								000 - 255	<b>Outer Green</b> , 0% to 100%
3	3	3		3								000 - 255	<b>Outer Blue</b> , 0% to 100%
4	4	4										000 - 255	<b>Inner White</b> , 0% to 100%
							30	33				000 - 255	<b>Inner White Group 1</b>
							31	34				000 - 255	<b>Inner White Group 2</b>
							32	35				000 - 255	<b>Inner White Group 3</b>
							33	36				000 - 255	<b>Inner White Group 4</b>
5	5	6										000 - 255	<b>Dimmer</b> , 0% to 100%
6	6	7										000 - 255	<b>Dimmer Fine</b> , 0% to 100%
				5			25	26			98	000 - 255	<b>Outer Dimmer</b> , 0% to 100%
				6			26	27			99	000 - 255	<b>Outer Dimmer Fine</b> , 0% to 100%
													<b>Strobe Effect</b>
												000 - 002	Open
												003 - 005	Strobe
												006 - 050	Ramp up
												051 - 100	Ramp down
												101 - 150	Ramp up-down
												151 - 200	Lightning
												201 - 255	Random
	8	9										000 - 255	<b>Strobe Rate</b> , slow to fast
	9	10										000 - 255	<b>Strobe Duration</b> , slow to fast
		5		4				25			97	000 - 255	<b>Outer Color Macros</b>
													<b>Outer Strobe Effect</b>
												000 - 002	Open
												003 - 005	Strobe
												006 - 050	Ramp up
												051 - 100	Ramp down
												101 - 150	Ramp up-down
												151 - 200	Lightning
												201 - 255	Random
				8			28	29			101	000 - 255	<b>Outer Strobe Rate</b> , slow to fast
				9			29	30			102	000 - 255	<b>Outer Strobe Duration</b> , slow to fast

CONTINUED ON NEXT PAGE

# DMX TRAITS

CHANNEL											DMX VALUES	FUNCTION							
6 CH	9 CH	13 CH	16 CH	18 CH	32 CH	32A CH	38 CH	43 CH	64 CH	112 CH			127 CH						
																	<b><i>Outer Program Macro</i></b>		
																	000 - 005	No function	
																	006 - 015	Macro1	
																	016 - 025	Macro2	
																	026 - 035	Macro3	
																	036 - 045	Macro4	
																	046 - 055	Macro5	
																	056 - 065	Macro6	
																	066 - 075	Macro7	
																	076 - 085	Macro8	
																	086 - 095	Macro9	
																	096 - 105	Macro10	
			11														106 - 115	Macro11	
				10													116 - 125	Macro12	
																	126 - 135	Macro13	
																	136 - 145	Macro14	
																	146 - 155	Macro15	
																	156 - 165	Macro16	
																	166 - 175	Macro17	
																	176 - 185	Macro18	
																	186 - 195	Macro19	
																	196 - 205	Macro20	
																	206 - 215	Macro21	
																	216 - 225	Macro22	
																	226 - 235	Macro23	
																	236 - 245	Macro24	
																	246 - 255	Macro25	
				11													104	000 - 255	<b><i>Outer Program Macro Speed</i></b>
				12				34	37								121	000 - 255	<b><i>Inner Dimmer, 0% to 100%</i></b>
				13				35	38								122	000 - 255	<b><i>Inner Dimmer Fine, 0% to 100%</i></b>

CONTINUED ON NEXT PAGE

# DMX TRAITS

CHANNEL												DMX VALUES	FUNCTION
6 CH	9 CH	13 CH	16 CH	18 CH	32 CH	32A CH	38 CH	43 CH	64 CH	112 CH	127 CH		
				14			36	39			123		<b>Inner Strobe Effect</b>
												000 - 002	Open
												003 - 005	Strobe
												006 - 050	Ramp up
												051 - 100	Ramp down
												101 - 150	Ramp up-down
												151 - 200	Lightning
												201 - 255	Random
				15			37	40			124	000 - 255	<b>Inner Strobe Rate</b> , slow to fast
				16			38	41			125	000 - 255	<b>Inner Strobe Duration</b> , slow to fast
													<b>Inner Program Macro</b>
												000 - 005	No function
												006 - 033	Macro1
												034 - 060	Macro2
												061 - 088	Macro3
												089 - 116	Macro4
												117 - 144	Macro5
												145 - 172	Macro6
												173 - 200	Macro7
												201 - 228	Macro8
												229 - 255	Macro9
				18				43			127	000 - 255	<b>Inner Program Macro Speed</b>
		13										000 - 255	<b>In/Out Program Macro Speed</b> , slow to fast
			1		1	1	1	1	1	1	1	000 - 255	<b>Red 1</b>
			2		2	2	2	2	2	2	2	000 - 255	<b>Green 1</b>
			3		3	3	3	3	3	3	3	000 - 255	<b>Blue 1</b>
			4		4	4	4	4	4	4	4	000 - 255	<b>Red 2</b>
			5		5	5	5	5	5	5	5	000 - 255	<b>Green 2</b>
			6		6	6	6	6	6	6	6	000 - 255	<b>Blue 2</b>
			7		7	7	7	7	7	7	7	000 - 255	<b>Red 3</b>
			8		8	8	8	8	8	8	8	000 - 255	<b>Green 3</b>
			9		9	9	9	9	9	9	9	000 - 255	<b>Blue 3</b>
			10		10	10	10	10	10	10	10	000 - 255	<b>Red 4</b>
			11		11	11	11	11	11	11	11	000 - 255	<b>Green 4</b>

CONTINUED ON NEXT PAGE

# DMX TRAITS

CHANNEL												DMX VALUES	FUNCTION
6 CH	9 CH	13 CH	16 CH	18 CH	32 CH	32A CH	38 CH	43 CH	64 CH	112 CH	127 CH		
			12		12	12	12	12	12	12	12	000 - 255	<i>Blue 4</i>
					13	13	13	13	13	13	13	000 - 255	<i>Red 5</i>
					14	14	14	14	14	14	14	000 - 255	<i>Green 5</i>
					15	15	15	15	15	15	15	000 - 255	<i>Blue 5</i>
					16	16	16	16	16	16	16	000 - 255	<i>Red 6</i>
					17	17	17	17	17	17	17	000 - 255	<i>Green 6</i>
					18	18	18	18	18	18	18	000 - 255	<i>Blue 6</i>
					19	19	19	19	19	19	19	000 - 255	<i>Red 7</i>
					20	20	20	20	20	20	20	000 - 255	<i>Green 7</i>
					21	21	21	21	21	21	21	000 - 255	<i>Blue 7</i>
					22	22	22	22	22	22	22	000 - 255	<i>Red 8</i>
					23	23	23	23	23	23	23	000 - 255	<i>Green 8</i>
					24	24	24	24	24	24	24	000 - 255	<i>Blue 8</i>
									25	25	25	000 - 255	<i>Red 9</i>
									26	26	26	000 - 255	<i>Green 9</i>
									27	27	27	000 - 255	<i>Blue 9</i>
									28	28	28	000 - 255	<i>Red 10</i>
									29	29	29	000 - 255	<i>Green 10</i>
									30	30	30	000 - 255	<i>Blue 10</i>
									31	31	31	000 - 255	<i>Red 11</i>
									32	32	32	000 - 255	<i>Green 11</i>
									33	33	33	000 - 255	<i>Blue 11</i>
									34	34	34	000 - 255	<i>Red 12</i>
									35	35	35	000 - 255	<i>Green 12</i>
									36	36	36	000 - 255	<i>Blue 12</i>
									37	37	37	000 - 255	<i>Red 13</i>
									38	38	38	000 - 255	<i>Green 13</i>
									39	39	39	000 - 255	<i>Blue 13</i>
									40	40	40	000 - 255	<i>Red 14</i>
									41	41	41	000 - 255	<i>Green 14</i>
									42	42	42	000 - 255	<i>Blue 14</i>
									43	43	43	000 - 255	<i>Red 15</i>
									44	44	44	000 - 255	<i>Green 15</i>
									45	45	45	000 - 255	<i>Blue 15</i>

CONTINUED ON NEXT PAGE

# DMX TRAITS

CHANNEL												DMX VALUES	FUNCTION
6 CH	9 CH	13 CH	16 CH	18 CH	32 CH	32A CH	38 CH	43 CH	64 CH	112 CH	127 CH		
									46	46	46	000 - 255	<i>Red 16</i>
									47	47	47	000 - 255	<i>Green 16</i>
									48	48	48	000 - 255	<i>Blue 16</i>
										49	49	000 - 255	<i>Red 17</i>
										50	50	000 - 255	<i>Green 17</i>
										51	51	000 - 255	<i>Blue 17</i>
										52	52	000 - 255	<i>Red 18</i>
										53	53	000 - 255	<i>Green 18</i>
										54	54	000 - 255	<i>Blue 18</i>
										55	55	000 - 255	<i>Red 19</i>
										56	56	000 - 255	<i>Green 19</i>
										57	57	000 - 255	<i>Blue 19</i>
										58	58	000 - 255	<i>Red 20</i>
										59	59	000 - 255	<i>Green 20</i>
										60	60	000 - 255	<i>Blue 20</i>
										61	61	000 - 255	<i>Red 21</i>
										62	62	000 - 255	<i>Green 21</i>
										63	63	000 - 255	<i>Blue 21</i>
										64	64	000 - 255	<i>Red 22</i>
										65	65	000 - 255	<i>Green 22</i>
										66	66	000 - 255	<i>Blue 22</i>
										67	67	000 - 255	<i>Red 23</i>
										68	68	000 - 255	<i>Green 23</i>
										69	69	000 - 255	<i>Blue 23</i>
										70	70	000 - 255	<i>Red 24</i>
										71	71	000 - 255	<i>Green 24</i>
										72	72	000 - 255	<i>Blue 24</i>
										73	73	000 - 255	<i>Red 25</i>
										74	74	000 - 255	<i>Green 25</i>
										75	75	000 - 255	<i>Blue 25</i>
										76	76	000 - 255	<i>Red 26</i>
										77	77	000 - 255	<i>Green 26</i>
										78	78	000 - 255	<i>Blue 26</i>
										79	79	000 - 255	<i>Red 27</i>

CONTINUED ON NEXT PAGE

# DMX TRAITS

CHANNEL												DMX VALUES	FUNCTION
6 CH	9 CH	13 CH	16 CH	18 CH	32 CH	32A CH	38 CH	43 CH	64 CH	112 CH	127 CH		
										80	80	000 - 255	<b>Green 27</b>
										81	81	000 - 255	<b>Blue 27</b>
										82	82	000 - 255	<b>Red 28</b>
										83	83	000 - 255	<b>Green 28</b>
										84	84	000 - 255	<b>Blue 28</b>
										85	85	000 - 255	<b>Red 29</b>
										86	86	000 - 255	<b>Green 29</b>
										87	87	000 - 255	<b>Blue 29</b>
										88	88	000 - 255	<b>Red 30</b>
										89	89	000 - 255	<b>Green 30</b>
										90	90	000 - 255	<b>Blue 30</b>
										91	91	000 - 255	<b>Red 31</b>
										92	92	000 - 255	<b>Green 31</b>
										93	93	000 - 255	<b>Blue 31</b>
										94	94	000 - 255	<b>Red 32</b>
										95	95	000 - 255	<b>Green 32</b>
										96	96	000 - 255	<b>Blue 32</b>
			13		25	25			49	97	105	000 - 255	<b>White 1</b>
			14		26	26			50	98	106	000 - 255	<b>White 2</b>
			15		27	27			51	99	107	000 - 255	<b>White 3</b>
			16		28	28			52	100	108	000 - 255	<b>White 4</b>
					29	29			53	101	109	000 - 255	<b>White 5</b>
					30	30			54	102	110	000 - 255	<b>White 6</b>
					31	31			55	103	111	000 - 255	<b>White 7</b>
					32	32			56	104	112	000 - 255	<b>White 8</b>
									57	105	113	000 - 255	<b>White 9</b>
									58	106	114	000 - 255	<b>White 10</b>
									59	107	115	000 - 255	<b>White 11</b>
									60	108	116	000 - 255	<b>White 12</b>
									61	109	117	000 - 255	<b>White 13</b>
									62	110	118	000 - 255	<b>White 14</b>
									63	111	119	000 - 255	<b>White 15</b>
									64	112	120	000 - 255	<b>White 16</b>



# LED PIXEL ZONES

## 6-, 9-, 13-, AND 18-CHANNEL MODE

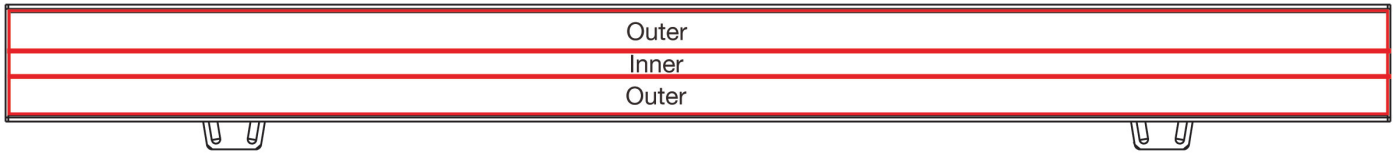

## 16-CHANNEL MODE

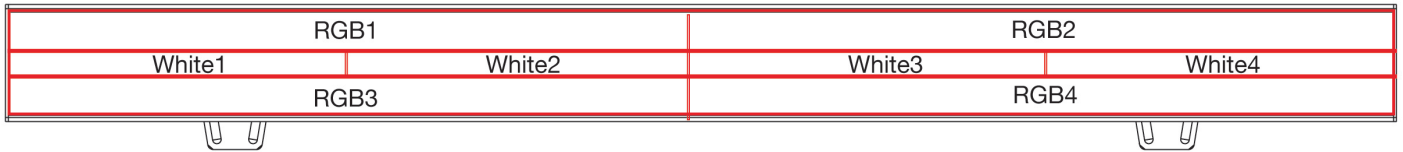

## 32-CHANNEL MODE

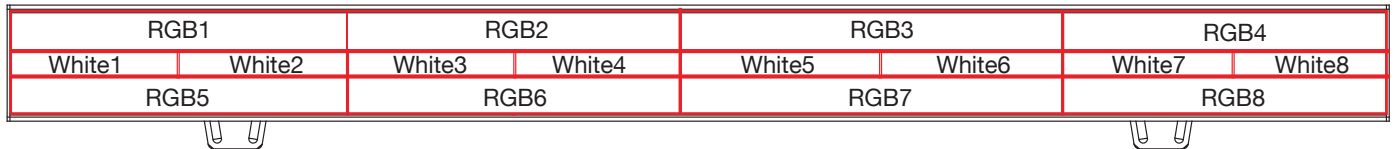

## 32A-CHANNEL MODE

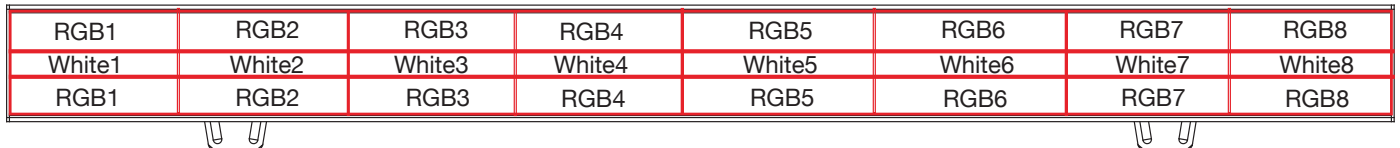

## 38- AND 43-CHANNEL MODE

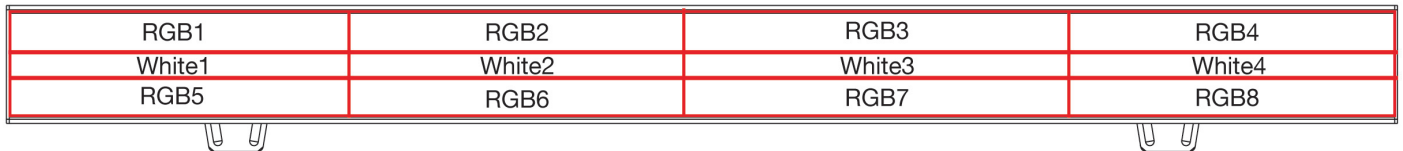

## 64-CHANNEL MODE

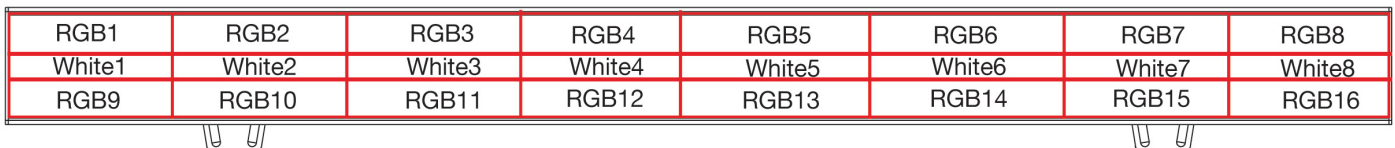

## 112- AND 127-CHANNEL MODE

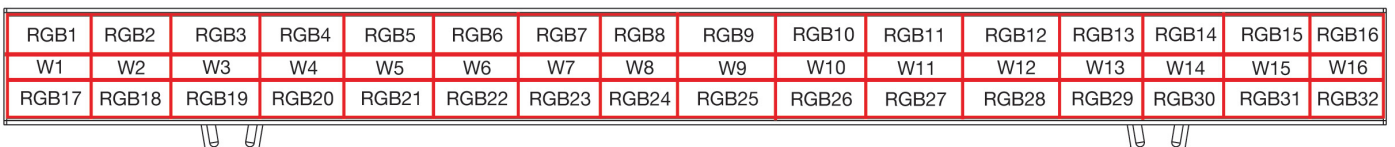

# DIMMER MODES AND CURVES

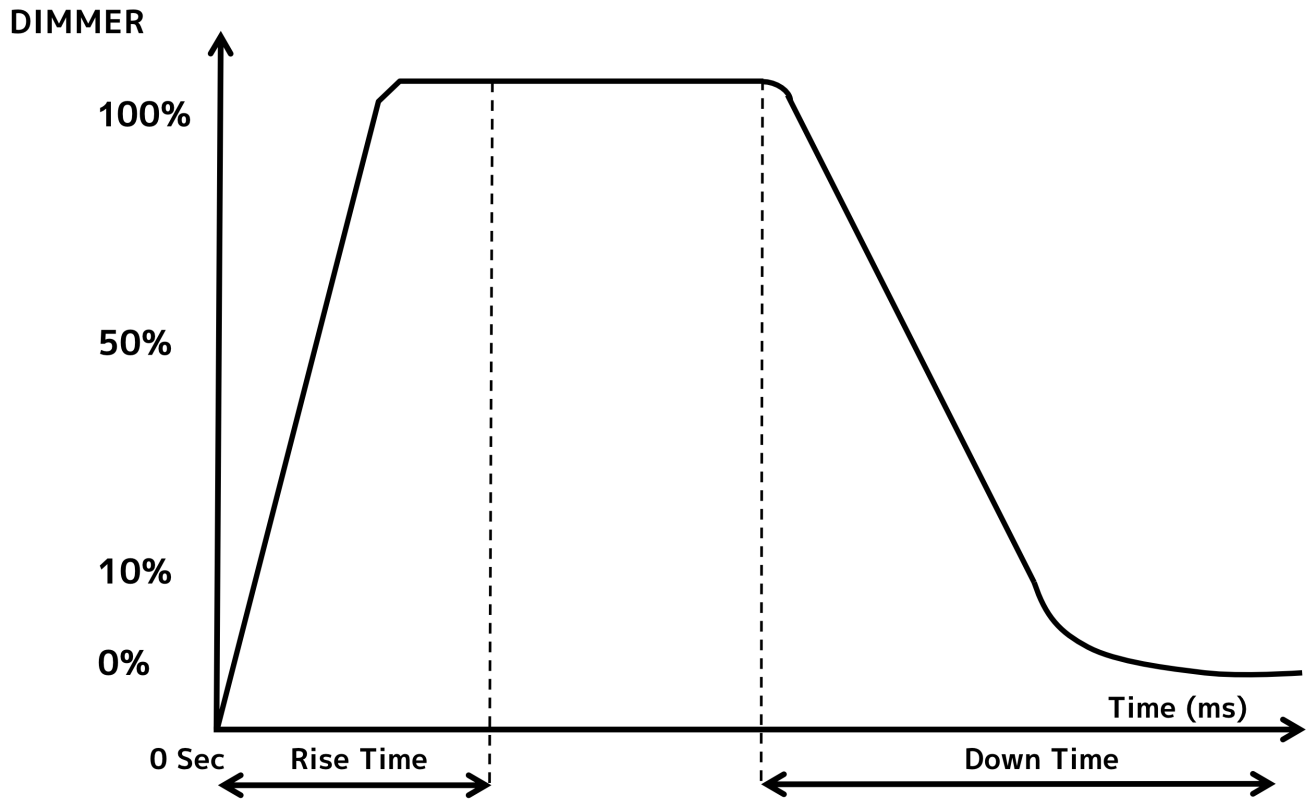

Dimming Curve Ramp Effect	0 sec Fade Time		1 sec Fade Time	
	Rise Time (ms)	Down Time (ms)	Rise Time (ms)	Down Time (ms)
Standard (default)	0	0	0	0
Stage	780	1100	1540	1660
TV	1180	1520	1860	1940
Architectural	1380	1730	2040	2120
Theatre	1580	1940	2230	2280
Stage 2	0	1100	0	1660

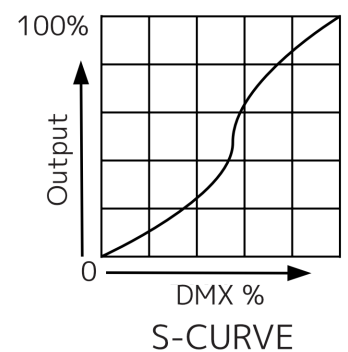
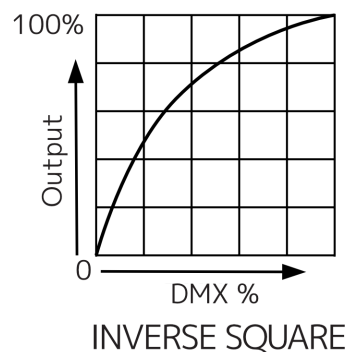
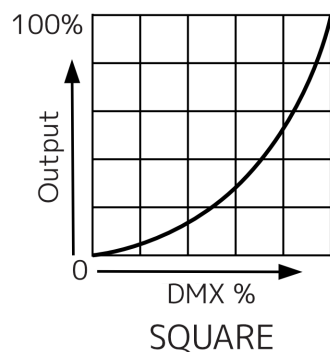
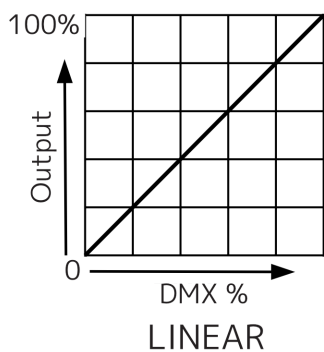

## DAISY CHAIN POWER LINKING

These units have the capability to be daisy chained together via the power in/out ports. **The maximum number of units that can be linked together in this manner is as follows:**

- 4 units maximum when running on 120V power.
- 8 units maximum when running on 230V power.

**DO NOT EXCEED THE NUMBER OF UNITS LISTED ABOVE.**

**DO NOT MIX MAKE AND MODEL TYPES WHEN DAISY CHAINING!** All units that are connected in this manner must be of the same make and model type.

## CLEANING AND MAINTENANCE



**DISCONNECT POWER BEFORE PERFORMING ANY MAINTENANCE!**

### CLEANING

Frequent cleaning is recommended to ensure proper function, optimized light output, and an extended life. The frequency of cleaning depends on the environment in which the fixture operates: damp, smoky, or particularly dirty environments can cause greater accumulation of dirt on the fixture's optics. Clean the external lens surface periodically with a soft cloth to avoid dirt/debris accumulation.

**NEVER** use alcohol, solvents, or ammonia-based cleaners.

### MAINTENANCE

Regular inspections are recommended to ensure proper function and extended life. There are no user serviceable parts inside this fixture. Please refer all other service issues to an authorized ADJ service technician. Should you need any spare parts, please order genuine parts from your local ADJ dealer.

Please refer to the following points during routine inspections:

- A detailed electrical check by an approved electrical engineer every three months, to make sure the circuit contacts are in good condition and prevent overheating.
- Be sure all screws and fasteners are securely tightened at all times. Loose screws may fall out during normal operation, resulting in damage or injury as larger parts could fall.
- Check for any deformations on the housing, color lenses, rigging hardware, and rigging points (ceiling, suspension, trussing). Deformations in the housing could allow for dust or liquids to enter into the fixture. Damaged rigging points or unsecured rigging could cause fixture to fall and seriously injure a person(s).
- Electric power supply cables must not show any damage, material fatigue, or sediments.

**NEVER** remove the ground prong from the power cable.

# DIMENSIONS

Dimensions are not drawn to scale.

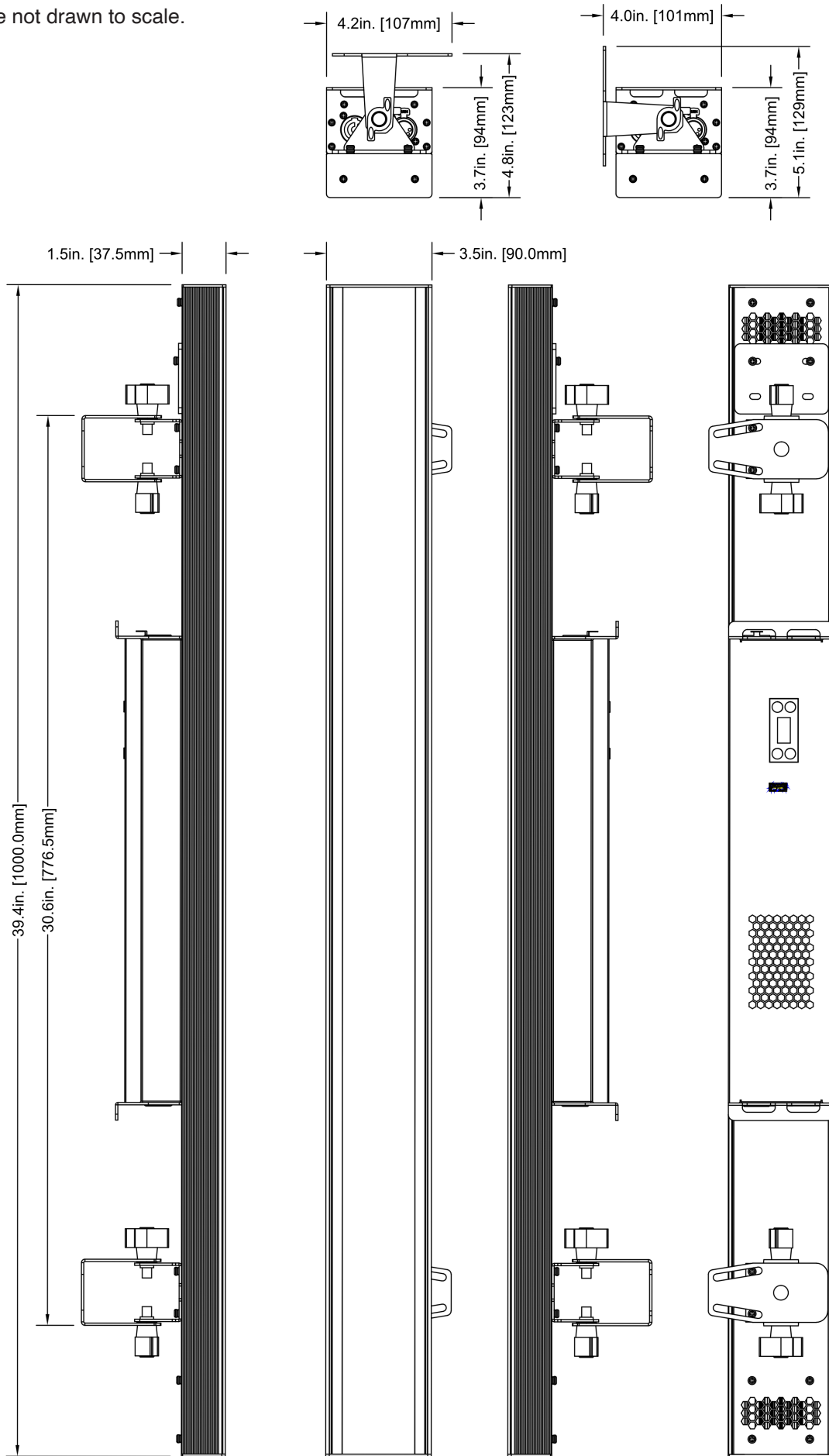

# SPECIFICATIONS

## LIGHT SOURCE:

- 448 x 0.3W RGB SMD LEDs + 112 x 5W Cool White SMD LEDs
- 116 Degree Beam Angle
- Color Temperature: Red: 620-630nm. Green: 515-525nm. Blue: 460-470nm. / Cool White: 5500-7000K
- 50,000 Hour Average LED Life

## FEATURES:

- 32 x RGB LED zones
- 16 x Cool White LED
- 25 built-in RGB LED Program Macros
- 9 built-in Cool White LED Program Macros

## CONTROL:

- Control Protocol: DMX
- 11 DMX Modes: 6, 9, 13, 16, 18, 32, 32A, 38, 43, 64, 112 and 127 channels
- 0-100% Smooth Dimming
- Strobe, shutter & pulse control
- Max Strobe Rate 25Hz. Min Strobe Rate: 0.35Hz.
- With Wired Digital Communication Network
- Display: LCD display with 4-button touch menu

## CONNECTIONS:

- Data: 5-pin DMX In/Out
- 180 degree mounting bracket system
- Power locking power in/out
- Connect fixtures seamlessly using included metal bracket attachment

## ELECTRICAL:

- 100-240V, 50Hz/60Hz (Auto Sensing)
- Max Power Consumption: 430W

## DIMENSIONS / WEIGHT:

- Length: 39.4" (1000mm)
- Width: 4.2" (107mm)
- Height: 4.8" (123mm)
- Weight: 13.88 lbs. (6.3kg)

## CERTIFICATIONS:

- CE / ETL / UKCA



Specifications and manual are subject to change and improvement without prior written notice.

## **FCC STATEMENT**

This device complies with Part 15 of the FCC Rules ADJ PRODUCTS LLC 6122 S. Eastern Ave, Los Angeles, CA, 90040. Operation is subject to the following two conditions: (1) this device may not cause harmful interference, and (2) this device must accept any interference received, including interference that may cause undesired operation. Please note that changes or modifications of this product is not expressly approved by the party responsible for compliance could void the user's authority to operate the equipment.

## **FCC RADIO FREQUENCY INTERFERENCE WARNINGS & INSTRUCTIONS**

This product has been tested and found to comply with the limits as per Part 15 of the FCC Rules. These limits are designed to provide reasonable protection against harmful interference in a residential installation. This device uses and can radiate radio frequency energy and, if not installed and used in accordance with the included instructions, may cause harmful interference to radio communications. However, there is no guarantee that interference will not occur in a particular installation. If this device does cause harmful interference to radio or television reception, which can be determined by turning the device off and on, the user is encouraged to try to correct the interference by one or more of the following methods:

- Reorient or relocate the device.
- Increase the separation between the device and the receiver.
- Connect the device to an electrical outlet on a circuit different from which the radio receiver is connected.
- Consult the dealer or an experienced radio/TV technician for help.

## **Europe Energy Saving Notice**

Energy Saving Matters (EuP 2009/125/EC)

Saving electric energy is a key to help protecting the environment. Please turn off all electrical products when they are not in use. To avoid power consumption in idle mode, disconnect all electrical equipment from power when not in use. Thank you



*This page intentionally left blank.*

