



Z-1200 III
Stage Fog Machine
User Manual
- English
- 中文



© 2023 Antari Lighting and Effects Ltd.

1. Introduction	1
2. Safety Information	1
3. Package Contents & Inspection	2
4. Machine Details	3
5. Technical Label Information	3
6. Fog Liquid	3
7. Setting and Manual Operation	4
8. Control Settings	4
9. Machine Status	5
10. DMX Connection	6
11. RDM Function	6
12. Z-3 Cable Remote (Optional)	7
13. Z-50 Wireless Remote (Optional)	7
14. Service and Maintenance	7
15. Technical Specifications	8
16. Warranty Disclaimer	8
17. Machine Dimension	9
1. 前言	10
2. 安全注意事項	10
3. 包裝內容與檢查	11
4. 機器訊息	12
5. 技術標籤資訊	12
6. 煙霧水	12
7. 設定與手動操作說明	13
8. 控制設定	13
9. 機器狀態	14
10. DMX 說明	14
11. RDM 功能	15
12. Z-3 有線控制器(選配)	16
13. Z-50 無線控制器(選配)	16
14. 維護和保養	16
15. 技術規格	17
16. 保固聲明	17
17. 機器尺寸圖	18
Appendix I Grounding Instruction	19



User Manual

1. Introduction

Please read all the user manual before operating the machine, and place the manual where the user can refer to it at all time. The manual includes how to install and operate the machine under safe conditions and explain all the labels printed on the machine. If you encounter any problem, contact your local Antari dealer for assistant immediately.

2. Safety Information

	DANGER	If the danger is not avoided, it will cause death or serious injury
	WARNING	If the warning is not heeded, it can cause death or serious injury.
	CAUTION	If the precaution is not taken, it may cause minor or moderate injury.



DANGER

- Must connect the machine to the correct rated voltage or it might lead to an electrical shock or a burn and may cause serious consequences.
- Must connect the machine to a protected circuit and ensure it is properly grounded to avoid the risk of electrocution. For grounding instruction, please refer to Appendix I on page 19.
- Do not operate the machine with a bundled power cord, it could lead to a fire hazard.
- When operating the machine, do not point at people, animals, or fire.



WARNING

- Machine's nozzle is extremely hot, please keep at least 50cm distance from the nozzle when the machine is running.
- Please operate the machine on a flat, level hard and well ventilated surface area, reserve at least 50cm space around the machine and make sure there is no flammable gas or material nearby.
- Do not disassemble, repair or modify the machine, it may cause damages, malfunction, risk of electrical shock or result in fire.
- The machine can only be operated by adults or professionals, is not intended for use by person with reduced physical sensory, mental capabilities, or lack of experience and knowledge including children.
- Do not leave the machine running unattended, make sure all powers are off when leaving.
- Children should be supervised to ensure that they do not play with the machine.
- Do not use the machine upside down or tilt it, it might cause damages or malfunction.
- Please store the fluid inside in a well ventilated area without direct sunlight and keep out of reach of children. In case of eye contact or accidentally swallow the fluid, please seek medical attention immediately.



CAUTION

- Keep the machine dry at all time. The machine is not waterproof, do not expose the machine to water, rain or moisture environment.
- Please make sure the power outlet is not damaged or loose before plug in the power cord.

- If the power cord is damaged, it must be replaced by Antari or its local dealers, otherwise the warranty will be void.
- Before operating the machine, please sure the fluid is filled in the fluid tank to avoid the pump in idling state which could lead to overeat or malfunction.
- Before transporting the machine, please make sure the fluid is drained and tank is empty. (Recommend using original package)
- The machine is for indoor use only.
- Do not operate the machine in any area with unstable voltage.
- If you experience strange sound or malfunction, turn off the power and unplug the power cord immediately and contact your local Antari dealer for assistant.
- Do not contact any moving part.
- Only use accessories recommended or sold by Antari.
- Please make sure the power is off when not using the machine and unplug the power cord if not intend to use for a long period of time.
- To disconnect, turn all controls to the off position, then remove plug from outlet.
- Do not unplug by pulling on cord. To unplug, grasp the plug, not the cord.
- Unplug from outlet before servicing or cleaning.
- Do not operate the machine with a damaged cord or plug, or after the machine malfunctions or is dropped or damaged in any manner. Return machine to the nearest authorized service facility for examination, repair, or electrical or mechanical adjustment.
- To ensure the lifespan of the machine, please only use the fluid manufactured by Antari, do not use other fluid or additive, otherwise it may clog the heater and cause malfunction.

Before operating the machine, please read all warning labels on the machine, description as below;

Top Cover Printing

WARNING!

HOT NOZZLE!

KEEP AT LEAST 50 CM DISTANCE

Rear Cover Printing

WARNING!

DISCONNECT POWER BEFORE CHANGING FUSE.

USE ONLY WITH ADULT SUPERVISION.

DO NOT OPERATE WITHOUT LIQUID.

FOR INDOOR USE ONLY. KEEP DRY.

NO USER SERVICEABLE PARTS INSIDE.

LIQUID

ONLY USE MANUFACTURER DESIGNATED FLUID.

ATTENTION!

NEVER ADD FLAMMABLE SUBSTANCES.

3. Package Contents & Inspection

Immediately upon receiving the machine, carefully unpack the carton, check the content to ensure it is the correct model and all parts are included. If any part appears to be damaged or missing during transportation, please contact your local dealer and return in original package for inspection.

3.1 Package Contents

1 x Z-1200 III Fog Machine

1 x Power Cable

1 x Hanging Bracket

1 x User Manual or Scan QR Code on the Machine

3.2 Optional Accessories

Item Code	Description
Z-3	Cable Remote
Z-50	Wireless Remote

4. Machine Details

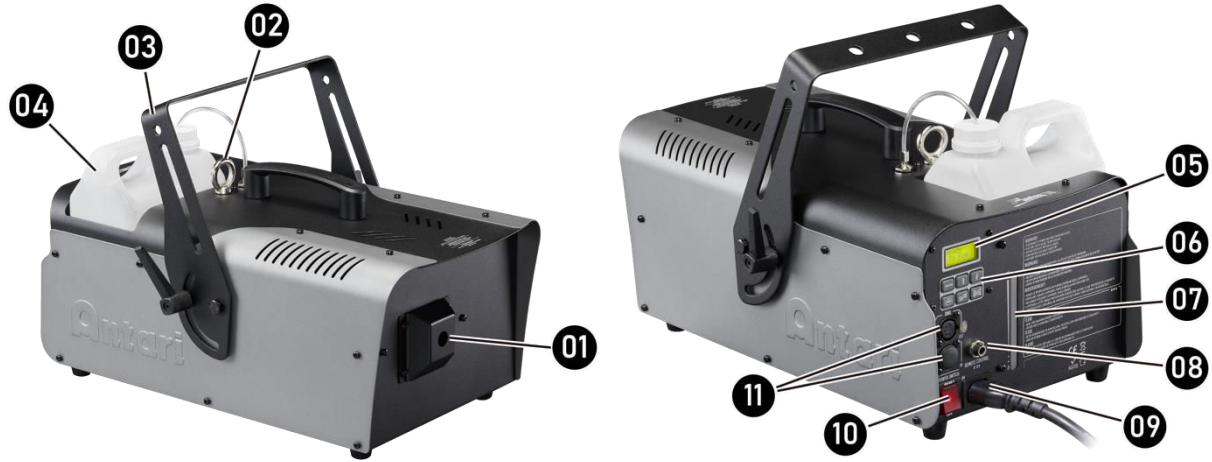

01. Fog Nozzle	07. Fluid Indicator
02. Safety Ring	08. Cable Remote Connector
03. Hanging Bracket	09. IEC Connector (Power)
04. 2.5 Liter Fluid Tank	10. Two in One Power & Breaker Switch
05. LCD Display	11. XLR 5-Pin Connector (DMX)
06. Operating Buttons	

5. Technical Label Information

Please read the technical label information on the back of the machine before operating it.

1. Model Name	5. Breaker/Fuse
2. Input Voltage	6. QR CODE for User Manual
3. Frequency	7. Serial No.
4. Rated Power	



6. Fog Fluid

	CAUTION!	Always turn off the power before filling the fluid tank. Do not add flammable liquid to the fluid tank. If fluid gets inside the machine, please contact your local Antari dealer for assistant.
--	-----------------	--

- Only the fog fluid manufactured by Antari can be used, do not mix or dilute the fog fluid. Due to improper storage or using other fluid might clog the heater and cause malfunction.
- The machine is tested and calibrated with the specific fog fluid to get the best performance.
- Please empty the fluid in the tank before switching to another fluid to avoid mixing.
- Only the essence manufactured by Antari can be used, and add according to the ratio recommended by Antari (Recommended ratio is 1:1000), if using other essence or different ratio might clog the heater and cause malfunction.
- The warranty on your Fog Machine will be void if you use fog fluid not manufactured by the Antari.

7. Setting and Manual Operation

	WARNING	Machine falling off might cause serious injury, please make sure it is secure and firm on the overhead.
---	----------------	---

- Step 1.** Place the machine on a flat, level hard and well ventilated surface area and reserve at least 50cm open space around the machine, and make sure there is no flammable gas or material nearby;
- Step 2.** Fill the fluid tank with Antari approved fog liquid, and make sure the tube is not twisted;
- Step 3.** Connect the machine to the power outlet. Please read the technical label on the back of the machine and make sure the power outlet is the correspond to the rated voltage for the machine;
- Step 4.** Turn on the machine, warm up process takes approximately 10 minutes. Once the machine has reached operating temperature, the LCD display will show “Ready To Fog”. Now the machine is ready for operation;
- Step 5.** To start fogging, press [TIMER] once and to stop fogging, press [TIMER] again or press [MANUAL], this will run based on “interval” & “duration” setting in the main menu;
- Step 6.** To start fogging, you can also press [VOLUME] button once and to stop fogging, press [VOUME] again or press [MANUAL]. You can adjust the output by press  and  button;
- Step 7.** To turn off the machine, please make sure the machine is not operating then turn of the power. If you will not use the machine a long period of time, please remove the power cord.

8. Control Settings





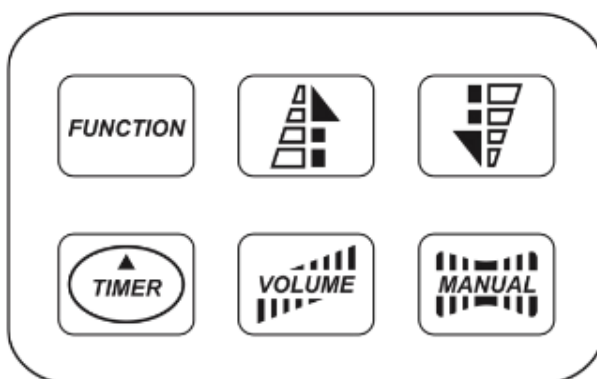

Z-1200 III Fog Machine can be operated in the following modes. The machine can only accept 1 type of signal at a time.

- Manual
- Timer
- DMX512
- Wireless
- Cable Remote

8.1 Control Panel Description



Z-1200 III Fog Machine can be operated with the onboard digital control interface.

Button	Operating Method	Action
	Press	To enter setting menu
	Press	Increase value
	Press	Decrease value
	Press	1. Press to start fogging according to the set time 2. Press again to stop fogging
	Press	1. Press to start fogging according to set volume output 2. Press again to stop fogging
	Press	1. Press and hold 3 sec. to force fogging and drain the air out of the tube 2. Press once to choose function in set menu 3. Leave setting menu 4. Stop fogging

8.2 Menu Options Description

Options	Description
Interval	Set Interval between 1-200 sec
Duration	Set Duration between 1-200 sec
Timer	1-100% / NONSTOP
Volume	1-100% / NONSTOP
DMX512 Add.001	001-512
Fluid Sensor	On / Off
Run Last Set	On / Off
Backlite	AutoOff / AlwaysOn
KeySound	On / Off
Fluid Type	FLG / FLR / FLZ / FLY / FLJ / FLH
Default Proceed	Yes / No

9. Machine Status

9.1 Machine Status with LCD Display



Screen	Description
Z-1200 III v1.0	Software Version
AC-120V 60Hz	Input Voltage
Ready To Fog	Machine is ready to Operate
Remote Out 100%	Cable Remote In Use
Volume Out 100%	Fog Output level at Manual Mode
Interval 200 sec	Running at Timer Mode, Interval Time
Duration 200 sec	Running at Timer Mode, Duration Time
DMX-512; Add: 001	DMX
Manual Output	Priming Fluid
RunSleep 180 sec	Sleep Mode Countdown: 180 sec
Warming Up 10%	Heating Up
Heater Overheat	Heater is Overheated
Heater Fault	Heater Malfunction
Thermal Line Off	Thermal Line Break Off
Line Reversed	Thermal Line Reverse Connection
Wrong!! AC Power	Incorrect AC Power

**If LCD control panel display “Warning”, please stop operating and turn off the machine immediately. Please contact your local Antari dealer for assistance.

10. DMX Connection

10.1 DMX Connector Pin Assignment

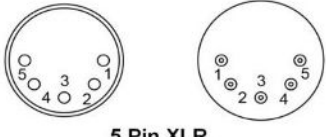
The machine has a XLR 5-Pin for DMX connection. The diagram below indicates pin assignment information.

 <p>5 Pin XLR</p> <table border="1" style="width: 100%; border-collapse: collapse;"> <thead> <tr> <th style="width: 20%;">Pin</th> <th style="width: 80%;">Function</th> </tr> </thead> <tbody> <tr> <td style="text-align: center;">1</td> <td>Ground</td> </tr> <tr> <td style="text-align: center;">2</td> <td>Data-</td> </tr> <tr> <td style="text-align: center;">3</td> <td>Data+</td> </tr> <tr> <td style="text-align: center;">4</td> <td>NA</td> </tr> <tr> <td style="text-align: center;">5</td> <td>NA</td> </tr> </tbody> </table>	Pin	Function	1	Ground	2	Data-	3	Data+	4	NA	5	NA	<p>** There is a protection cap on DMX IN, please remove it with your finger before operation.</p> 
Pin	Function												
1	Ground												
2	Data-												
3	Data+												
4	NA												
5	NA												

10.2 DMX Channel Function

1 Channel Mode		DMX Value Range	Function
Channel 1	Fog Output Level	0 – 5	Off
		6 – 255	1 – 100%

11. RDM Function

The Z-1200 III Fog Machine is RDM enabled, allowing control system to configure, monitor and manage. See below table for supported RDM parameters.

GET Allowed	SET Allowed	Category	RDM Parameter ID's(Slot 21-22)	Value	Required
		NetworkManagement 網路管理	DISC_UNIQUE_BRANCH	0x0001	O
				0x0002	O
				0x0003	O
O		RDM Information RDM 資訊	QUEUED_MESSAGE	0x0020	
O			STATUS_MESSAGES	0x0030	
O			SUPPORTED_PARAMETERS	0x0050	O
O			PAPAMETER_DESCRIPTION	0x0051	O
O		Product Information 產品資訊	DEVICE_INFO	0x0060	O
O			PRODUCT_DETAIL_ID_LIST	0x0070	
O			DEVICE_MODE_DESCRIPTION	0x0080	
O			MANUFACTURER_LABEL	0x0081	
O	O		DEVICE_LABEL	0x0082	
O			SOFTWARE_VERSION_LABEL	0x00C0	O
O	O	DMX512 Setup DMX512 設定	DMX_PERSONALITY	0x00E0	
O			DMX_PERSONALITY_DESCRIPTION	0x00E1	
O	O		DMX_START_ADDRESS	0x00F0	O
O			SLOT_INFO	(0x0120)	

O			SLOT DESCRIPTION	(0x0121)	
O			DEFAULT_SLOT_VALUE	(0x0122)	
O		Sensors	SENSOR_DEFINITION	0x020	
O	O	感應器	SENSOR_VALUE	0x0201	
O		Control	DEVICE_HOURS	0x0400	
O	O	控制	IDENTIFY_DEVICE	0x1000	O
O	O		POWER_STATE	0x1010	

12. Z-3 Cable Remote (Optional)



Z-3 Cable Remote is a standard accessory for Z-1200 III Fog Machine, please see instruction below;

1. Plug the cable remote to the connector on the back of the machine, red indicator light on (Power);
2. Press the switch (Orange Indicator Light on); turn the knob to adjust the output to start fogging;
3. Press the switch (Orange Indicator Light Off), or turn the knob to far left to stop fogging.

** If you encounter any problem, please contact your local Antari dealer for assistant.

13. Z-50 Wireless Remote (Optional)



Z-50 Wireless Remote is an optional accessory for Z-1200 III Fog Machine, it included a wireless remote control and a receiver. It's ready to use, no pairing necessary, please see instruction below;

1. Plug the receiver to the connector on the back of the machine;
2. Press either RED button to start fogging and release the RED button to stop fogging.

** Signal range is approximately 50m in open area, it may vary depending on actual situation on site.

** If you encounter any problem, please contact your local Antari dealer for assistant.

14. Service and Maintenance

	DANGER!	Disconnect the power cord before starting maintenance operation!
---	----------------	--

- Always keep the machine clean.

- Can use air compressor, vacuum or a soft brush to remove the dust on the machine.
- Can use a slightly damp cloth to clean the casing.
- Before store the machine, please make sure the machine is completely cool down to avoid moisture inside causing malfunction.
- It is recommended to run the machine at least once a month in order to maintain the machine's best performance and output condition.
- Excessive dust and build up liquid residue will reduce the performance and cause overheat.

14.1 Breaker Reset (2 in 1 Power Switch)

The 2 in 1 power switch combines power and breaker function. Please follow below steps to reset the breaker.

- Step 1: Please switch to the OFF position;
- Step 2: Wait 60 second;
- Step 3: Flip switch to ON position.

If the breaker (Switch) still jumps off after reset, please contact your local Antari dealer for assistance.

Breaker Specification

100-120V = 15A 250V
220-240V = 9A 250V



15. Technical Specifications

	Z-1200 III
Input Voltage	US Model : AC 100-120V, 50/60Hz 10A EU Model : AC 220-240V, 50/60Hz 5.5A
Rated Power	1200W
Warming-up Time	10 minutes (approx.)
Fluid Consumption	85 ml/min (100% output)
Fluid Tank Capacity	2.5 Liters (0.66 gallon)
Compatible Fluid	Antari FLG Heavy Fog Fluid 、 Antari FLR Light Fog Fluid 、 Antari FLY Antari FLZ Long Hang Time Fog Fluid 、 Antari FLJ Light Hang Time Fog Fluid 、 Antari FLH Dense Long Hang Time Fog Fluid
Ambient Temp. Range	0°C – 40°C (32°F – 104°F)
Control Methods	Manual 、 Timer 、 DMX512 、 Wireless (Optional) 、 Cable Remote (Optional)
Interface	XLR 5-Pin Connector (DMX) 、 IEC Connector (Power)
DMX Channels	1 Channel
Included Accessories	Hanging Bracket
Optional Accessories	Z-3 Cable Remote 、 Z-50 Wireless Remote
Dimension	L 458 W 243 H 251 mm (L 18.03 W 9.57 H 9.88 inch)
Weight	11.0 kg (24.2 lbs.)

16. Warranty Disclaimer

We guarantee the merchandise manufactured by us to be free from defect in material and workmanship for a period of one year. Our obligation and liability under this warranty shall be restricted to repair or replacement at our factory or local authorized dealer. We assume no liability of the products that are improperly used or used for any purpose other than that for which they are specially designed. This warranty shall not apply to any merchandise which has been repaired, altered or assembled outside our factory in any way so as in our judgment to affect its

performance, nor which has been subjected to misuse, negligence, or accident nor to any merchandise operated contrary to our printed instructions. We will not allow or be liable of any loss or any damages of any kind in connection with the use, sale, or repair of any merchandise purchased from us.

17. Machine Dimension







中文使用說明書

1. 前言

在操作本機器之前，請務必仔細詳閱本說明書然後請將本說明書放置在機器使用者可隨時查閱之處存放。此說明書包含如何安全的安裝及操作本機器以及說明所有在機器上的標示。如果您有任何操作上的問題，請立即聯繫當地的 Antari 經銷商尋求協助。

2. 安全注意事項

	危險	若不確實避免這些指示，可能導致嚴重人身傷害甚至死亡。
	警告	若不確實遵循這些指示，可能導致嚴重人身傷害甚至死亡。
	注意	若不確實注意這些指示，可能導致人身傷害甚至死亡，嚴重程度視情況而定。

危險

- 請務必使用正確電壓。如果使用錯誤電壓，可能會遭受危險的電擊燒傷或更嚴重的後果。
- 請務必將機器連結到有保護的電路，並確保有正確的接地，以避免觸電的危險。關於接地方式請參考第 19 頁附錄 I。
- 請勿在捆綁電源線的情況下使用，可能會發熱導致火災。
- 操作機器時請勿將機器對著人體、動物或火焰使用。

警告

- 機器的噴嘴非常燙。當機器工作時，請遠離噴嘴 50 公分以上。
- 請於堅固、平坦、穩定且通風良好的表面上使用機器。請勿遮蓋機器散熱部份，機器周邊至少應保留 50 公分的空間並確認附近沒有易燃性物質或可揮發性氣體。
- 請勿隨意拆卸、修理或改造機器，這可能會導致機器故障、損壞、觸電危險或造成火災。
- 本機器僅限有行為能力之成人或專業人員操作，不預期提供生理、感知、心智能力、經驗或知識不足者之使用者(包含孩童)使用本機器。
- 請勿在無人看管時讓機器運作，並於外出離去時確實關閉電源。
- 孩童應受監督，以確保孩童不能操作或嬉戲玩本機器。
- 請勿將機器倒放或傾斜使用，可能導致機器動作不正常或損壞。
- 請將液體存放在室內孩童無法取得之處，保持通風及避免陽光直射。如果有觸碰眼睛或誤食機器，請立即尋求醫生的協助。



注意

- 本機器無防水設計，請隨時保持機器乾燥，嚴禁將其潑水、浸水、淋雨或放在潮溼的環境。
- 在插入電源插座前，請確認電源插座無損壞或鬆動。
- 若電源線損壞，必須使用原廠電源線或組件進行更換，否則將導致保固無效。
- 請在使用機器之前，先填裝好煙霧水，避免機器幫浦空轉過熱造成損害。機器在搬運前或使用完畢後，請清空油桶。
- 在運輸本機器前，請確認機器的油箱已清空並且包裝完整。(建議使用原廠包裝)
- 本產品僅限室內使用。
- 請勿在電壓不穩定的地區使用本機器。
- 如果機器出現異常聲音或有任何不正常現象時，請立即停止工作，將電源關閉及拔下機器電源線，並請聯繫當地的 Antari 經銷商尋求協助。
- 請勿觸碰機器內部運轉零件。
- 只能使用原廠建議或販售之配件。
- 請確認機器不在使用的狀態下電源已關。如果長時間不使用機器，請拔掉電源線。
- 關閉機器時，將控制開關轉到關閉的位置，然後再將插頭從插座拔除。
- 拔除電源線時，請抓住插頭不是電線。
- 在保養及清潔前，請把電源線從插座拔除。
- 在電線或插座有損毀、機器故障或有掉落或損壞的情形發生時，請勿操作機器。請將機器送回最近的維修站，做檢查、維修及電源或機械的調整。
- 為確保機器的使用壽命，請使用 Antari 原廠製造之煙霧水，勿使用其它非 Antari 原廠製造煙霧水或添加劑，否則可能會導致電熱管阻塞和故障。

在使用本機之前，請詳細閱讀機器上的警語標示，說明如下：

上蓋印刷

WARNING! 警告!

HOT NOZZLE! 出煙口高溫!

KEEP AT LEAST 50 CM DISTANCE 請保持至少 50 公分的距離

後蓋印刷

WARNING! 警告!

DISCONNECT POWER BEFORE CHANGING FUSE. 更換保險絲前請務必斷開電源

USE ONLY WITH ADULT SUPERVISION. 僅在成人監督下使用

DO NOT OPERATE WITHOUT LIQUID. 請勿在沒有液體的情況操作本機台

FOR INDOOR USE ONLY. KEEP DRY. 僅限室內使用 請保持乾燥

NO USER SERVICEABLE PARTS INSIDE. 內部無使用者可維修之零配件

LIQUID 液體

ONLY USE MANUFACTURER DESIGNATED FLUID. 僅使用原廠認可的液體

ATTENTION! 注意!

NEVER ADD FLAMMABLE SUBSTANCES. 切勿添加易燃物質

3. 包裝內容與檢查

在收到機器後，請立即小心地打開包裝紙箱，檢查所有內容，確認您所購買的機型及配件。如果有任何部件因運輸過程出現損壞或缺少，請立即連絡經銷商，並以原包裝退回檢查。

3.1 包裝內容

1 x Z-1200 III 煙霧機

1 x 電源線

- 1 x 吊架
- 1 x 說明書或掃描機身 QR CODE

3.2 選配說明

品項	描述
Z-3	有線控制器
Z-50	無線控制器

4. 機器訊息

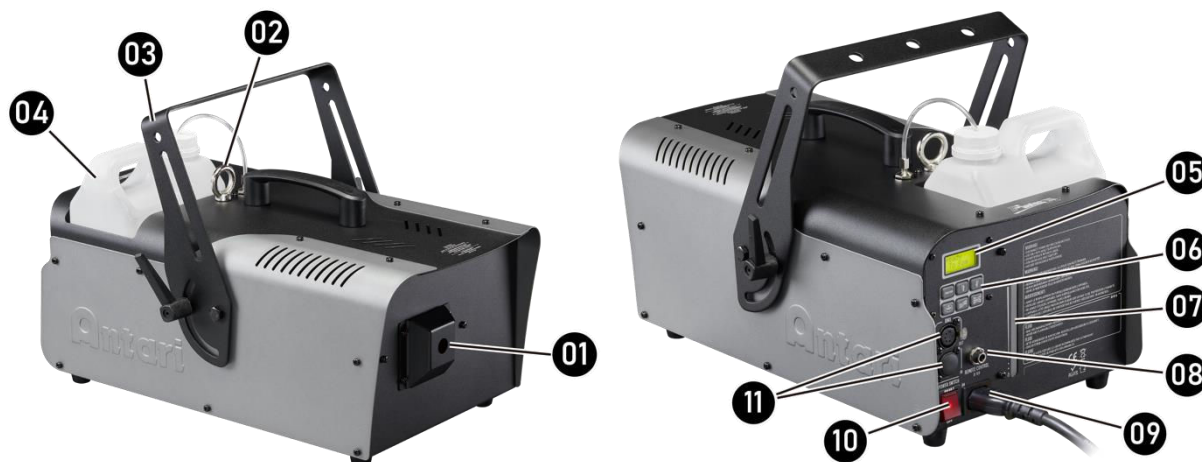

01. 噴煙口	07. 油量顯示
02. 安全吊環	08. 有線控制器接頭
03. 吊架	09. IEC 接頭(電源)
04. 2.5 公升油桶	10. 二合一電源&斷路器開關
05. 液晶顯示器	11. XLR 5-Pin 接頭(DMX)
06. 操作按鈕	

5. 技術標籤資訊

使用本機器前，請詳閱技術標籤上的訊息

	<p>XXXX INPUT VOLTAGE: FREQUENCY: RATED POWER: BREAKER/FUSE:</p> <p>XXXX Vac 50/60Hz XXXW XXA 250V MADE IN TAIWAN XXXXXMMYXXXXX</p> <p>Scan It for User Manual</p>
1. 機器型號	5. 斷路器/保險絲
2. 工作電壓	6. 說明書 QR CODE
3. 頻率	7. 機器流水序號
4. 瓦特數	



6. 煙霧水

	危險	將液體加入機器之前，請務必先拔除電源線。請勿添加易燃液體。如果發現液體流入機器內部，請洽 Antari 原廠或其經銷商尋求協助。
--	-----------	--

- 僅能使用 Antari 原廠製造之煙霧水，不可混用或稀釋。若因保存不當而變質或使用非原廠煙霧水，將可能造成電熱管堵塞而導致機器故障。
- 本機器是使用專屬的煙霧水做測試與校正來取得最佳的效能。
- 如需更換另一種液體，請在使用前，先將油桶中的液體清空，以避免混合。
- 僅能使用 Antari 原廠製造之香精，並依照原廠建議比例添加(原廠建議比例為 1:1000)，如果使用非原廠的香精或比例添加有誤，將可能造成電熱管阻塞而導致機器故障。
- 如果使用非原廠製造之煙霧水或香精而導致煙霧機損壞將不在保固範圍內。

7. 設定與手動操作說明

	警告! 機台掉落可能會造成嚴重傷害，請確保本機台安裝牢固且不會掉落。
---	---

- 步驟1.** 將機器平放在堅固、平坦、穩定且通風良好的表面上，機器周圍至少應保留 50 公分的空間並確認附近沒有易燃性物質或可揮發性氣體；
- 步驟2.** 使用 ANTARI 原廠專用煙霧水注入機器所附的油桶，並注意不要折到油管；
- 步驟3.** 將機器連接電源，連接之前，確認機器背後技術標籤上所標示要求功率，是否與電源插座相符；
- 步驟4.** 啟動機器電源後，使機器開始加熱。機器加熱到可工作溫度大約需要 10 分鐘。當機器達到工作溫度時，螢幕會顯示“Ready to Fog”，表示機器已經準備好可進行操作；
- 步驟5.** 欲開始噴煙，按一下控制面板上的[TIMER]；停止噴煙，請按一下控制面板上的[TIMER]，這會按照原廠設定的“間隔時間” & “持續時間”來運轉；
- 步驟6.** 或欲開始噴煙，按一下控制面板上的[VOLUME]；停止噴煙，請按一下控制面板上的 [VOLUME]，可以透過  和  鍵來調整噴量；
- 步驟7.** 需關閉本機時，請確認機器已停止運轉，再將電源開關關閉即可，長時間不使用時請移除電源線。

8. 控制設定

Z-1200 III 煙霧機可以使用下列操作模式，機器每次接受一種訊號。

- 手動控制
- 定時控制
- DMX512
- 無線控制
- 有線控制

8.1 控制面板說明

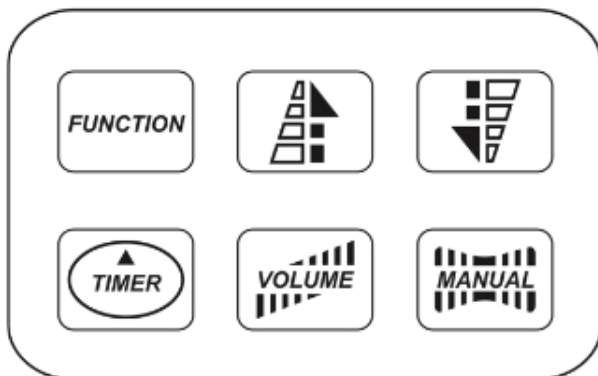

Z-1200 III 煙霧機可以使用機器上的數位控制面板來操作。

按鈕	操作方式	動作
	按	進入設置選單
	按	增加數值
	按	減少數值
	按	1. 按一下根據設定時間啟動噴煙 2. 再按一下停止噴煙
	按	1. 按一下根據設定輸出量噴煙 2. 在按一下停止噴煙
	按	1. 長按 3 秒啟動強制噴煙然後將空氣從油管中擠出 2. 按一下確認設定 3. 離開設置選單 4. 停止噴煙

8.2 選單說明

此機器無中文選單，請參照第五頁英文選單。

9. 機器狀態

9.1 機器狀態說明

面板畫面	說明
Z-1200 III v1.0	機器軟體版本
AC-120V 60Hz	電源電壓
噴煙就緒	噴煙預備中
線控輸出量 100 %	線控執行中
手動輸出量 100%	手動噴煙執行中
間隔時間 200 秒 啟動時間 200 秒	定時噴煙執行
DMX512 地址 001	DMX 執行中
手動強制噴煙	強制抽油執行中
休眠倒數 180 秒	休眠倒數：180 秒
機器加熱中 10 %	加熱中
機器過熱	加熱器過熱
電熱管異常	加熱器故障
溫度線斷開	溫度線斷開
溫度線反接	溫度線反接
錯誤的 AC 電源	錯誤的 AC 電源

**當控制面板出現警告的訊息，請立即停止操作機器並關閉電源之後，請與當地的 Antari 經銷商尋求協助。

10. DMX 說明

10.1 接點說明

本機器提供一個 XRL 5-Pin 的 DMX 連接頭。PIN 的接點說明如下：

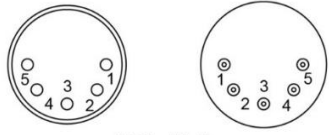

5 Pin XLR

Pin	功能
1	接地
2	數據-
3	數據+
4	NA
5	NA

**DMX IN 連接頭上有一個保護蓋，操作前，請用手指撥開即可將其取下。



10.2 DMX 通道功能

本機器提供一種 DMX 通道模式可供選擇，請參考下方表單。

1 通道模式		DMX 數值範圍	功能
通道 1	煙霧輸出量	0 – 5	關閉
		6 – 255	1 – 100%

11. RDM 功能

Z-1200 III 煙霧機配有 RDM 功能，讓使用者可以經由 DMX 網路使用 RDM 功能進行機台的設定、監控、管理。請參考下表相關 RDM 支援參數；

GET Allowed	SET Allowed	Category	RDM Parameter ID's(Slot 21-22)	Value	Required
		NetworkManagement 網路管理	DISC_UNIQUE_BRANCH	0x0001	○
				0x0002	○
				0x0003	○
○		RDM Information RDM 資訊	QUEUED_MESSAGE	0x0020	
○			STATUS_MESSAGES	0x0030	
○			SUPPORTED_PARAMETERS	0x0050	○
○			PAPAMETER_DESCRIPTION	0x0051	○
○		Product Information 產品資訊	DEVICE_INFO	0x0060	○
○			PRODUCT_DETAIL_ID_LIST	0x0070	
○			DEVICE_MODE_DESCRIPTION	0x0080	
○			MANUFACTURER_LABEL	0x0081	
○	○		DEVICE_LABEL	0x0082	
○			SOFTWARE_VERSION_LABEL	0x00C0	○
○	○	DMX512 Setup DMX512 設定	DMX_PERSONALITY	0x00E0	
○			DMX_PERSONALITY_DESCRIPTION	0x00E1	
○	○		DMX_START_ADDRESS	0x00F0	○
○			SLOT_INFO	(0x0120)	
○			SLOT_DESCRIPTION	(0x0121)	
○			DEFAULT_SLOT_VALUE	(0x0122)	
○		Sensors 感應器	SENSOR_DEFINITION	0x020	
○	○		SENSOR_VALUE	0x0201	
○		Control	DEVICE_HOURS	0x0400	

○	○	控制	IDENTIFY_DEVICE	0x1000	○
○	○		POWER_STATE	0x1010	

12. Z-3 有線控制器(選配)



Z-3 有線控制器是 Z-1200 III 煙霧機的選購配件，使用方法如下；

1. 將有線控制器插入機器後方的控制器接頭，紅色指示燈(電源)亮起；
2. 按下開關(橘燈亮起)，調整旋鈕，控制輸出量大小，開始噴煙；
3. 按下開關(橘燈熄滅)或旋鈕轉到最左邊，停止噴煙。

**如果有任何問題，請聯繫當地的 Antari 經銷商尋求協助。

13. Z-50 無線控制器(選配)



Z-50 無線控制器是 Z-1200 III 煙霧機的選購配件，它包含一個無線控制器和一個接收器。此配件是隨插即用，不需要做配對，使用方法如下；

1. 將接收器插入機器後方的接頭；
2. 長按任何一個紅色按鈕開始噴煙，放開紅色按鈕停止噴煙。

**如果有任何問題，請聯繫當地的 Antari 經銷商尋求協助。

14. 維護和保養

	危險!	維修保養之前，請務必拔除電源線！
--	------------	------------------

- 隨時保持機器清潔。
- 可以使用空氣壓縮機、吸塵器或軟刷除去機器上的灰塵。
- 機殼可使用濕布擦拭。
- 在存放或收起機器前，請確認機器完全冷卻，避免機器內部潮濕導致故障。
- 建議每月至少讓機器運轉一次，以保持機器處於最佳的性能和輸出條件。
- 機器上過多的灰塵、液體殘餘累積的髒污會降低機器工作性能，導致散熱不良。

14.1 重置斷路器 (二合一電源開關)

此二合一開關結合電源和斷路器功能。請依照以下步驟重置斷路器。

- 步驟 1: 請將此二合一開關切到 OFF 的位置;
- 步驟 2: 等待 60 秒;
- 步驟 3: 再將此二合一開關切到 ON 的位置即完成重置。

若重置斷路器後，依然跳掉的話，請與當地 Antari 經銷商聯繫，尋求協助。



斷路器規格

100-120V = 15A 250V
220-240V = 9A 250V

15. 技術規格

	Z-1200 III
電壓	美規 : AC 100-120V, 50/60Hz 10A 歐規 : AC 220-240V, 50/60Hz 5.5A
額定功率	1200 瓦
加熱時間	約 10 分鐘
耗油量	85 毫升/分鐘 (100%輸出)
水桶容量	2.5 公升(0.66 加侖)
適用煙霧水	Antari FLG 濃煙霧水、Antari FLR 淡煙霧水、Antari FLY 特濃煙霧水、 Antari FLZ 長停留時間煙霧水、Antari FLJ 短時間停留煙霧水、 Antari FLH 長時間停留濃煙霧水
適用環境溫度	0°C – 40°C (32°F – 104°F)
控制方式	手動控制、定時控制、DMX 512、無線控制(選配)、有線控制(選配)
連接座	XLR 5-Pin 連接頭(DMX)、IEC 連接頭(主電源)
DMX 512 通道	1 個頻道
隨附配件	吊架
選購配件	Z-3 有線控制器、Z-50 無線控制器
尺寸	長 458 寬 243 高 251 公釐 (長 18.03 寬 9.57 高 9.88 英寸)
重量	11.0 公斤 (24.2 磅)

16. 保固聲明

本公司保證我們的商品在一年內沒有材料和製作缺陷。我們在本保證下的義務和責任僅限於在原廠或當地授權經銷商進行的維修或更換。我們對不當使用或用於非專門設計目的以外之用途不承擔任何責任。本保固不適用於以任何方式在原廠或當地授權經銷商外修理、改動或組裝的任何商品，以便我們判斷影響其性能，沒有受到誤用、疏忽或事故的影響，也沒有違反我們的任何商品操作印刷說明。本公司對於從我們這邊購買的商品不會允許也不對於使用、銷售或修理任何產品有關的任何類型的任何損失或損害承擔責任。

17. 機器尺寸圖



Appendix I Grounding Instruction

This appliance must be grounded. In the event of malfunction or breakdown, grounding provides a path of least resistance for electric current to reduce the risk of electric shock. This appliance is equipped with a cord having an equipment-grounding conductor and a grounding plug. The plug must be plugged into an appropriate outlet that is properly installed and grounded in accordance with all local codes and ordinances.

DANGER – Improper connection of the equipment-grounding conductor can result in a risk of electric shock. The conductor with insulation having an outer surface that is green with or without yellow stripes is the equipment-grounding conductor. If repair or replacement of the cord or plug is necessary, do not connect the equipment-grounding conductor to a live terminal. Check with a qualified electrician or serviceman if the grounding instructions are not completely understood, or if in doubt as to whether the appliance is properly grounded. Do not modify the plug provided with the appliance – if it will not fit the outlet, have a proper outlet installed by a qualified electrician.

This appliance is for use on a nominal 120 V circuit, and has a grounding plug that looks like the plug illustrated in sketch A in Figure. A temporary adaptor, which looks like the adaptor illustrated in sketches B and C, may be used to connect this plug to a 2-pole receptacle as shown in sketch B if a properly grounded outlet is not available. The temporary adaptor should be used only until a properly grounded outlet can be installed by a qualified electrician. The green colored rigid ear, lug, and the like, extending from the adaptor must be connected to a permanent ground such as a properly grounded outlet box cover. Whenever the adaptor is used, it must be held in place by the metal screw.

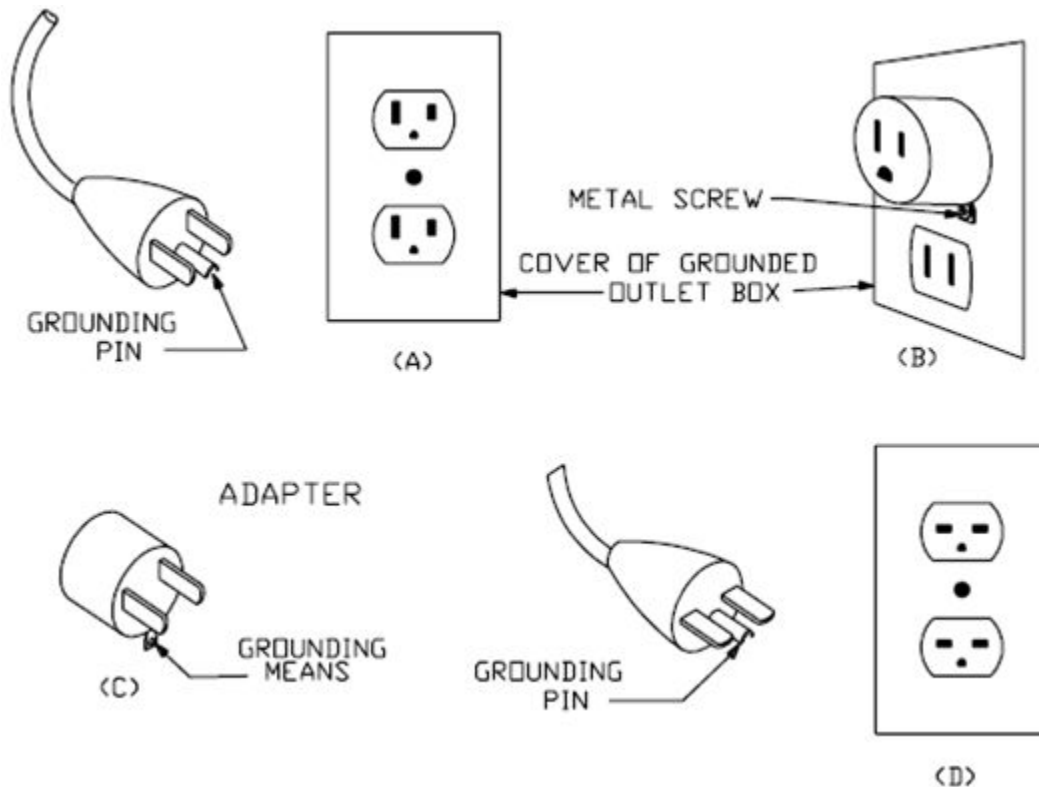



C08Z01201